

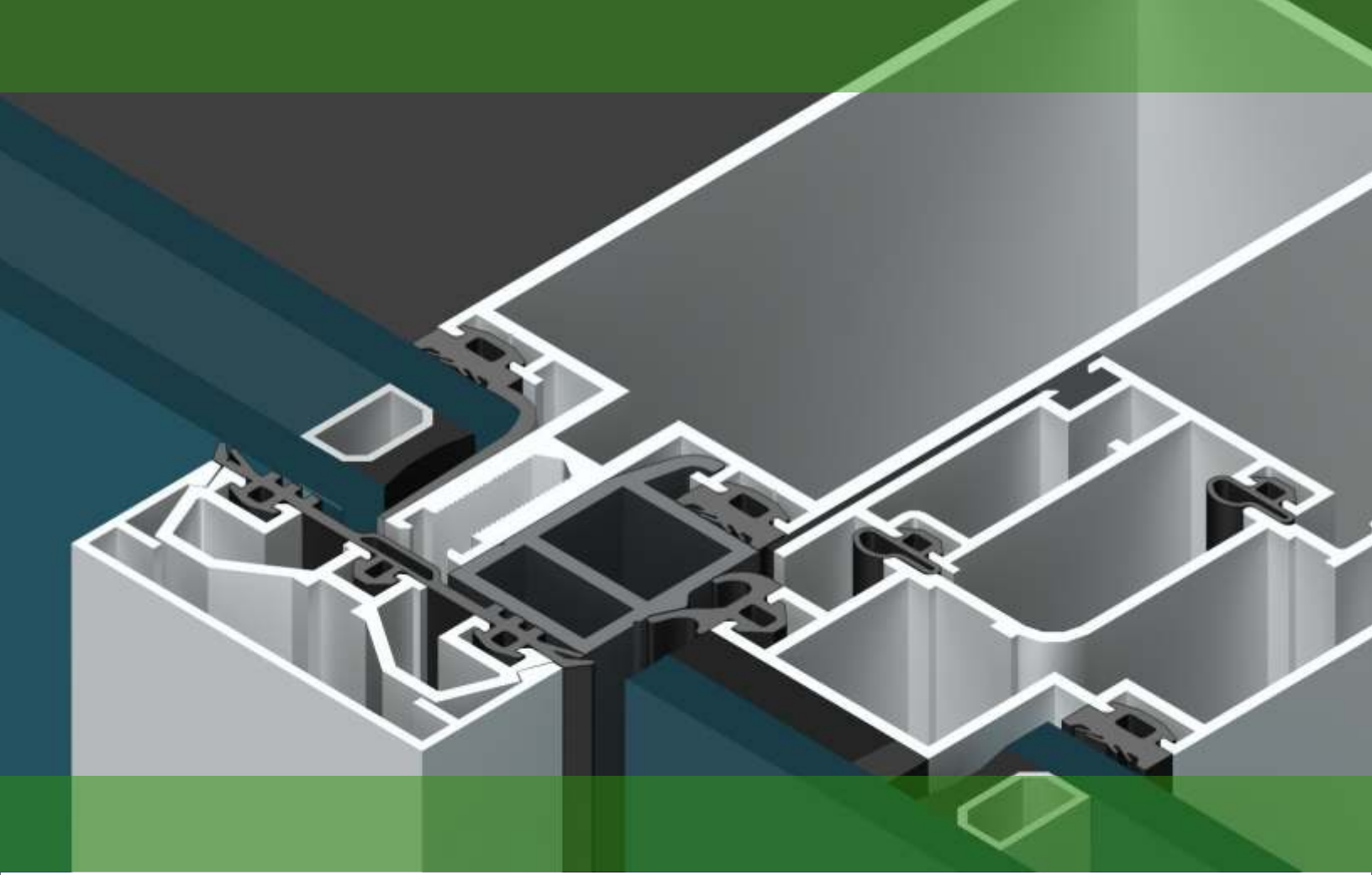

## SOĞUTUCU PROFİLLERİ VE AKSESUARLARI COOLER PROFILES & ACCESSORIES



**SOĞUTUCU PROFİLLERİ VE AKSESUARLARI**  
**COOLER PROFILES & ACCESSORIES**

**ALÜMİNYUM / ALUMINUM**

www.gurcan.com.tr



TÜRK PATENT [ ] ENSTİTÜSÜ

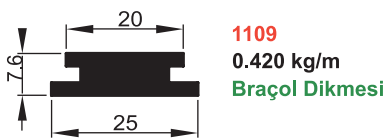
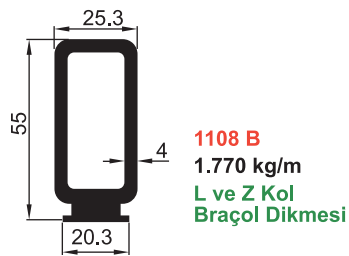
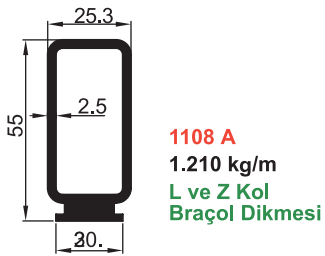
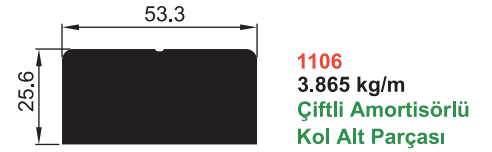
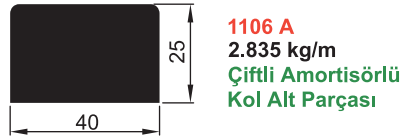
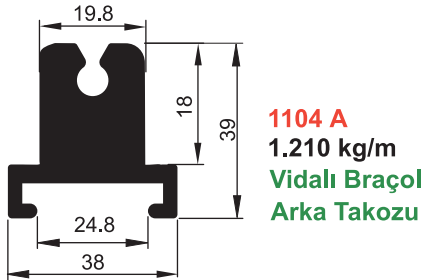
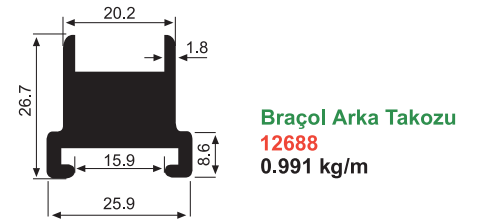
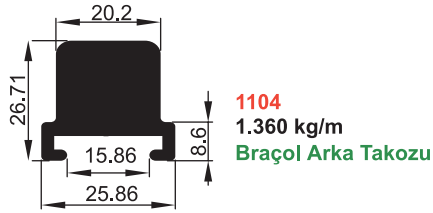
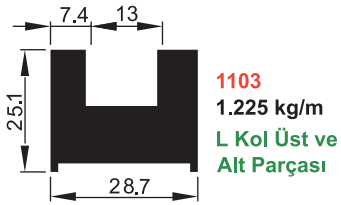
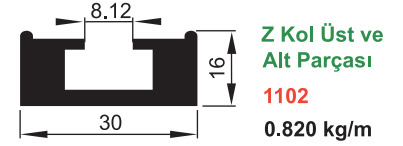
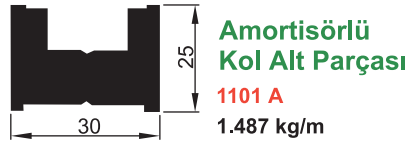
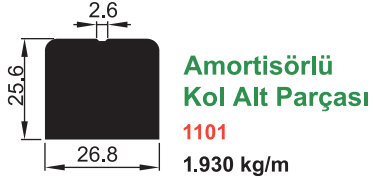

# ALÜMİNYUM / ALUMINUM AMORTİSÖRLÜ PROFİLLER

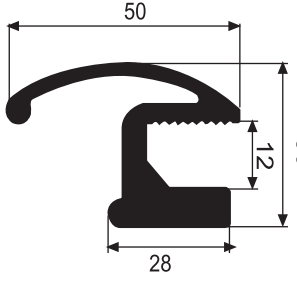

**1107 D**  
1.175 kg/m  
Amortisörlü Cam Tutamağı

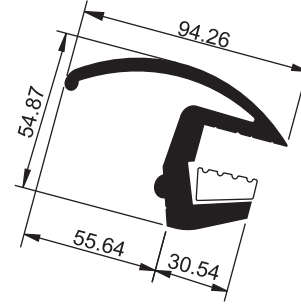

**1107 C**  
3.250 kg/m  
Amortisörlü Cam Tutamağı

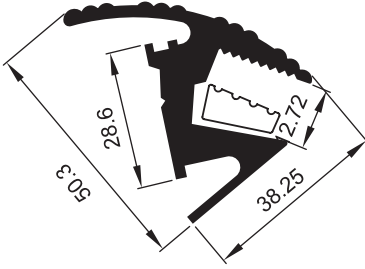

**1107 B**  
1.573 kg/m  
Tırtırlı Amortisörlü Cam Kanalı

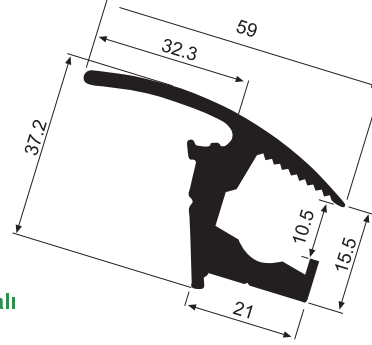

**12677**  
1.288 kg/m  
Amortisörlü Cam Kanalı

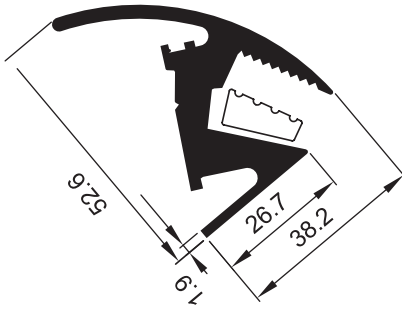

**1107 A**  
1.620 kg/m  
Amortisörlü Cam Kanalı



ÖRNEK RESİM  
SAMPLE PICTURE

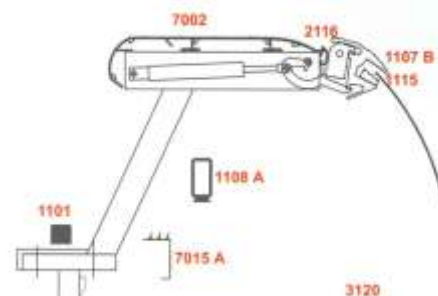

ÖRNEK / SAMPLE

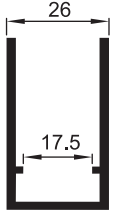

**1111**  
0.850 kg/m  
Braçol Kol Fitili

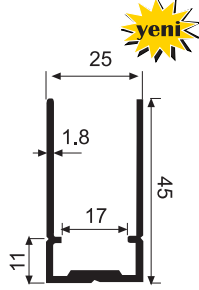

**2944**  
0.610 kg/m  
Braçol Kol Fitili

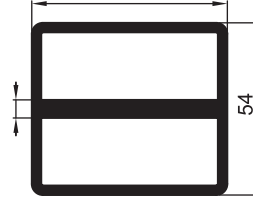

**1112**  
2.730 kg/m  
Çift Amortisör Kol Dikmesi  
Çiftli Kutu

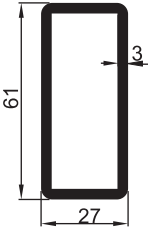

**1113**  
1.370 kg/m  
Amortisör Kol Dikmesi  
Tekli Kutu

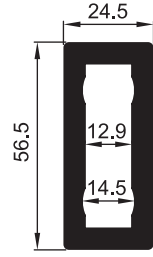

**1113 A**  
2.239 kg/m  
Amortisör Kol Dikmesi

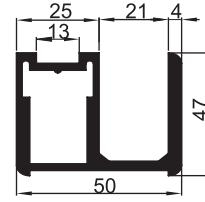

**1116**  
1.874 kg/m  
Tekli Kol Üstü

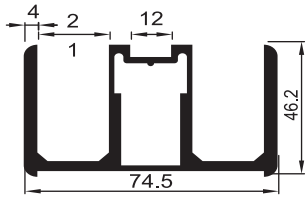

**1117**  
2.492 kg/m  
Çiftli Kol Üstü

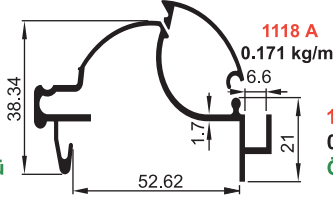

**1118 A**  
0.171 kg/m  
**1118**  
0.804 kg/m  
Ön Küşpeşte

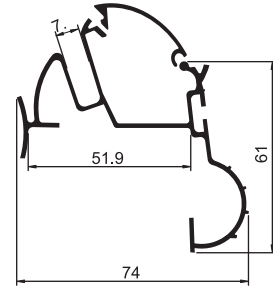

**1118 B**  
1.185 kg/m  
Ön Küşpeşte

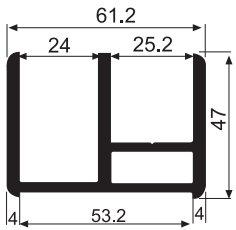

**12656**  
2.066 kg/m  
Tekli Kol Üstü  
Kovan Profili

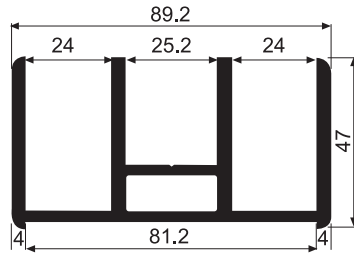

**12690**  
2.746 kg/m  
Çiftli Kol Üstü  
Kovan Profili

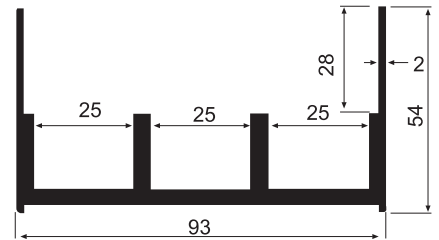

**12676**  
2.298 kg/m  
Çiftli Kol Üstü  
Kovan Profili

# ALÜMİNYUM / ALUMINUM PASTA VİTRİN PROFİLLERİ

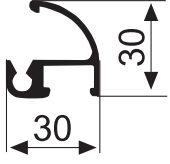

**1119**  
0.470 kg/m

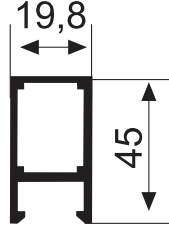

**1120**  
0.460 kg/m

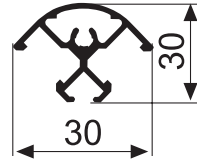

**1121**  
0.610 kg/m

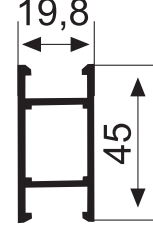

**1122**  
0.540 kg/m

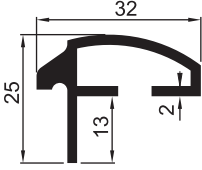

**2116**  
0.409 kg/m  
Devirme Önü

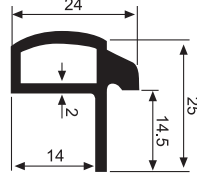

**12655**  
0.421 kg/m  
Devirme Önü

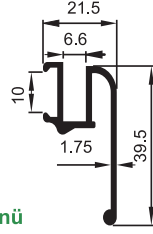

**3108**  
0.485 kg/m  
Amortisörlü  
Cam Tutamağı

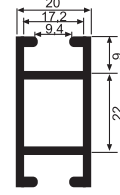

**1122 A**  
0,516 gr/m  
Vitrin Orta Kayıtı

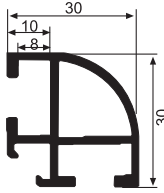

**1121 A**  
0,486 gr/m  
Vitrin  
Köşe Profili

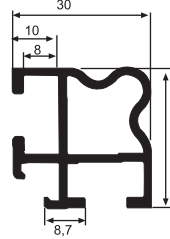

**1121 D**  
0,549 gr/m  
Dekoratif Köşe

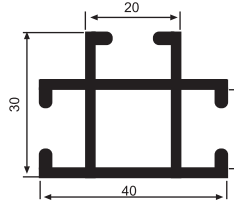

**1121 C**  
0,697 gr/m  
Opsiyonel Orta

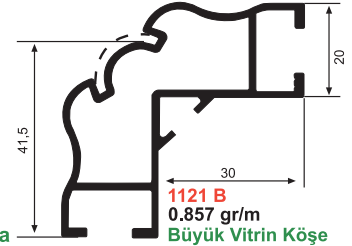

**1121 B**  
0,857 gr/m  
Büyük Vitrin Köşe



**ALÜMİNYUM / ALUMINUM**  
**YENİ AMORTİSÖRLÜ PROFİLLER**  
**NEW PROFILES WITH DAMPER**

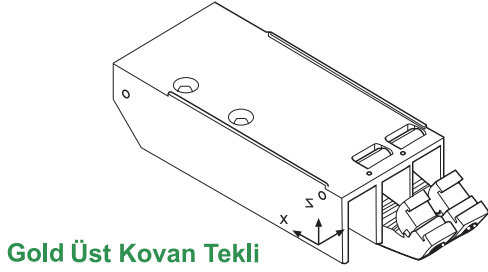

**Gold Üst Kovan Tekli**

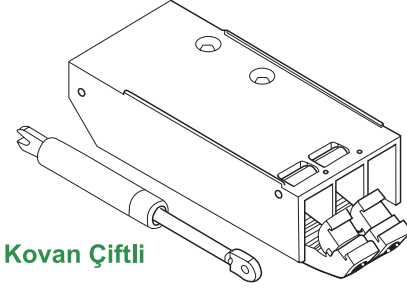

**Gold Üst Kovan Çiftli**

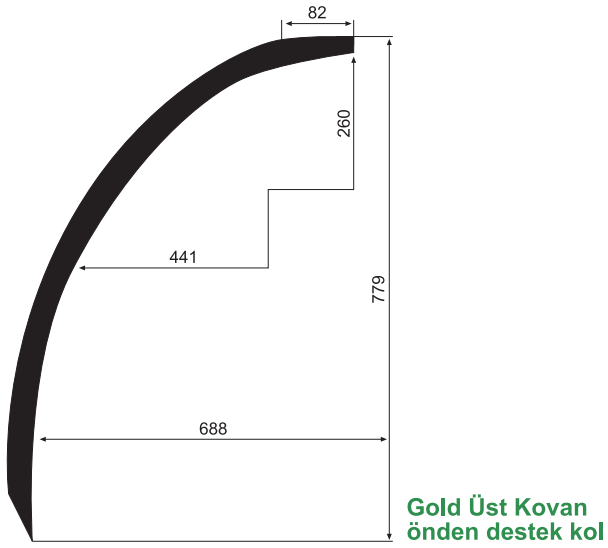

**Gold Üst Kovan  
önden destek kol**

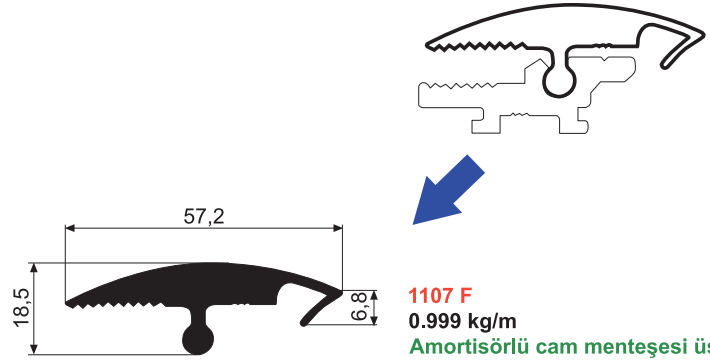

**1107 F**  
**0.999 kg/m**  
**Amortisörlü cam menteşesi üst**

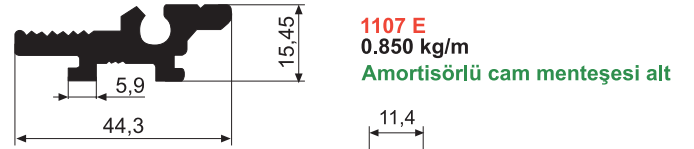

**1107 E**  
**0.850 kg/m**  
**Amortisörlü cam menteşesi alt**

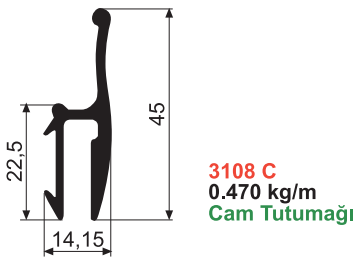

**3108 C**  
**0.470 kg/m**  
**Cam Tutumağı**

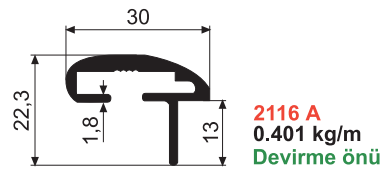

**2116 A**  
**0.401 kg/m**  
**Devirme önü**

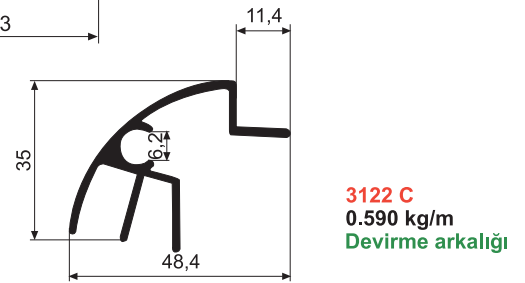

**3122 C**  
**0.590 kg/m**  
**Devirme arkalığı**

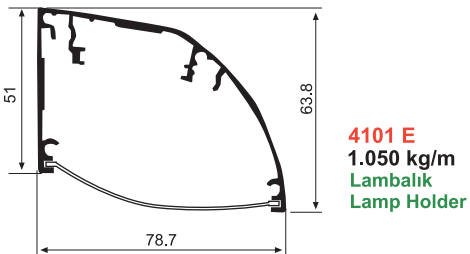

**4101 E**  
**1.050 kg/m**  
**Lambalık**  
**Lamp Holder**

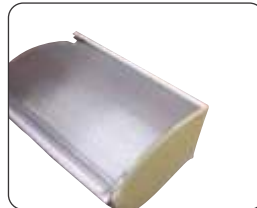

**4101 E**  
**E Yan Kapak**



**4101**  
**Polikarbon Kapak**

## ALÜMİNYUM / ALUMINUM AMORTİSÖRLÜ PROFİLLER PROFILES WITH DAMPER

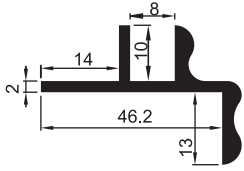

**2101**  
0.522 kg/m  
Çiftli Market

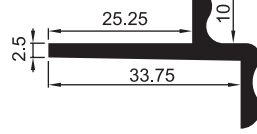

**2102**  
0.442 kg/m  
Tekli Market

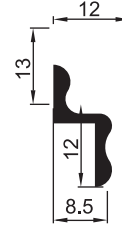

**2111**  
0.250 kg/m  
Tekli Market

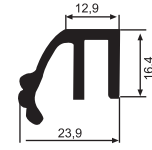

**2106 D**  
0.378 gr/m  
Süslü Cam Tutamağı

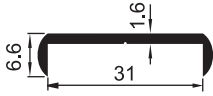

**2105 A**  
0.170 kg/m  
Sütlük Kenarı 31 mm

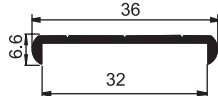

**2105 D ( SM1029 D )**  
0.185 kg/m  
Çizgili Sütlük Kenarı 45 mm

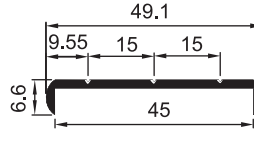

**2105 B ( SM 1029 A )**  
0.260 kg/m  
Çizgili Sütlük Kenarı 45 mm

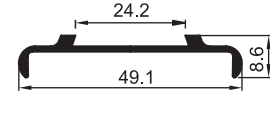

**2105 C ( SM1029 SB )**  
0.235 kg/m  
Çizgili Sütlük Kenarı 45 mm

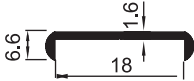

**2105 E**  
0.125 kg/m  
Sunta Kenarı 18 mm

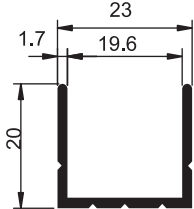

**2105 F ( 1055 E )**  
0.270 kg/m  
Sütlük Kenarı Isıcam "U" su

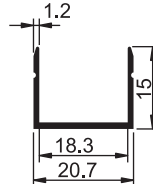

**2105 G ( 1055 H )**  
0.151 kg/m  
Sütlük Kenarı Isıcam "U" su

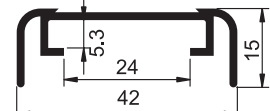

**2105 T**  
0.375 kg/m  
Sütlük Kenarı "U" su

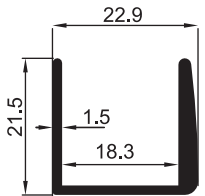

**2115 A ( SM 1055 )**  
0.330 kg/m  
Sütlük Kenarı Isıcam "U" su

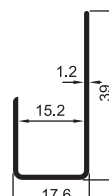

**2113 A**  
0.245 kg/m  
Topal "U" 15 mm.



**2114**  
0.200 kg/m  
Topal "U" 8 mm.

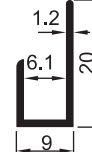

**2115**  
0.139 kg/m  
Topal "U" 6 mm.

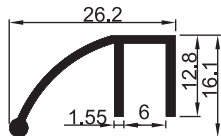

**2106 A**  
0.230 kg/m  
Cam Tutacağı

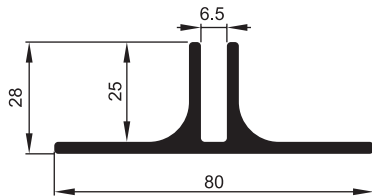

**2115 B**  
1.225 kg/m  
Cam Bölme



**2106 B**  
0.300 kg/m  
Cam Tutamağı



**2106 C**  
0.300 kg/m  
Cam Tutamağı



**2105 T Köşe Plastik**



## ALÜMİNYUM / ALUMINUM AMORTİSÖRLÜ PROFİLLER PROFILES WITH DAMPER

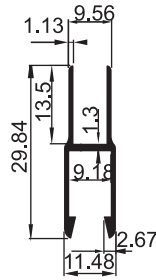
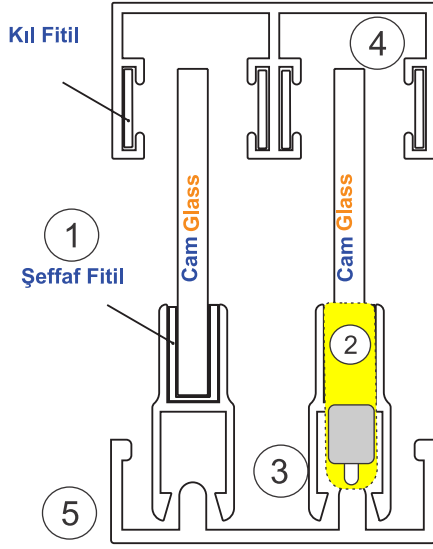

3 **2110 A**  
0.245 kg/m  
Sürgü "H" ı

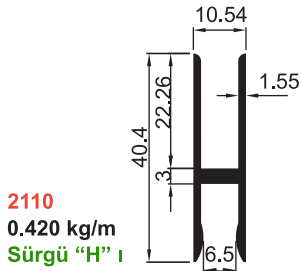
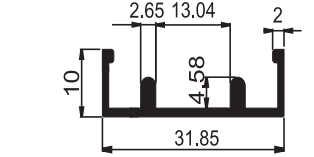
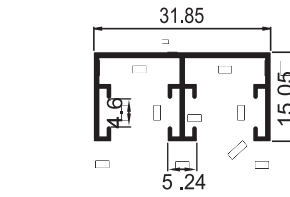
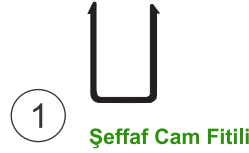

2110 B  
0.250 kg/m  
Bombe Cam Sürgü "H" ı

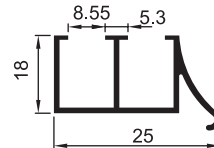
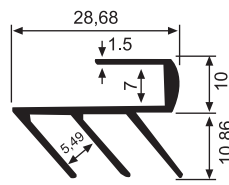
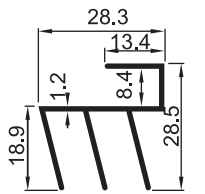

2112  
0.355 kg/m  
Sürgü Rayı

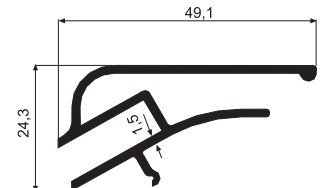
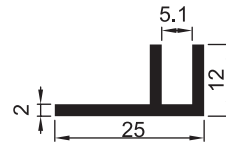
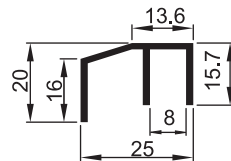
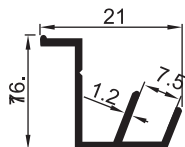
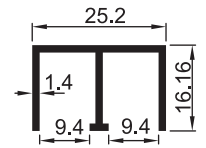

**ALÜMİNYUM / ALUMINUM  
KOLA DOLAP KAPI PROFİLLERİ  
COLA CABINET DOOR PROFİLES**

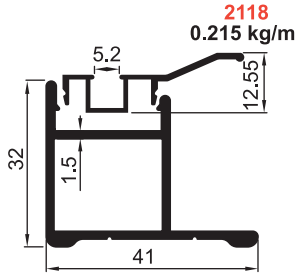

**2118**  
0.215 kg/m

**2117**  
0.555 kg/m  
Kola Dolap Kapısı

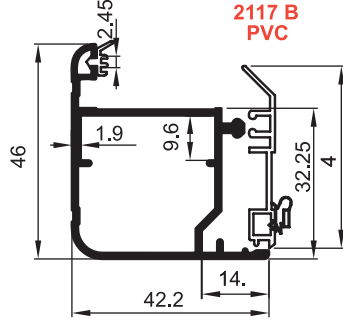

**2117 B**  
PVC

**2117 A**  
0.650 kg/m  
Kola Dolap Profili ve Cam Çıtası

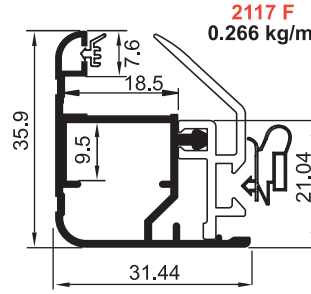

**2117 F**  
0.266 kg/m

**2117 E**  
0.495 kg/m  
Kola Dolap Profili ve Cam Çıtası

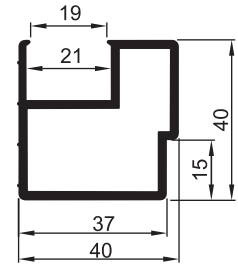

**2117 D**  
0.955 kg/m  
Kola Dolap Profili ( Çıtasız )

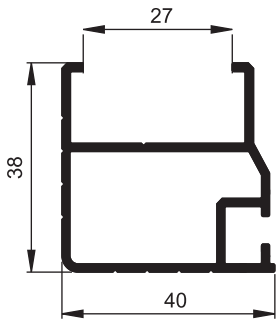

**2117 K**  
0.708 kg/m  
Kola Dolap Profili

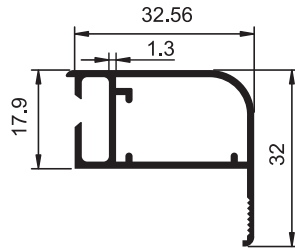

**2117 U**  
0.437 kg/m  
Kola Dolap Profili

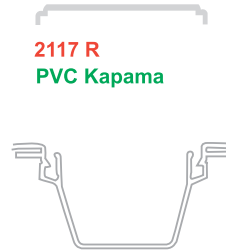

**2117 R**  
PVC Kapama

**SP008**  
Florasan kutu profili



**GC-120 R**

**GC-120 L**

**YAYLI YAN MENTEŞE  
UPRIGHT COOLER HINGE**



**YAN KAPI KOLU  
UPRIGHT COOLER HANDLE**

## ALÜMİNYUM / ALUMINUM ÖNE DEVİRME PROFİLLERİ ROLL OVER PROFILES

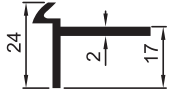

**2119**  
0.300 kg/m  
Ön Dayama

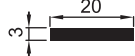

**3104**  
0.170 kg/m  
Cam Sıkıştırma

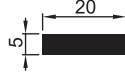

**3103**  
0.284 kg/m  
Cam Sıkıştırma

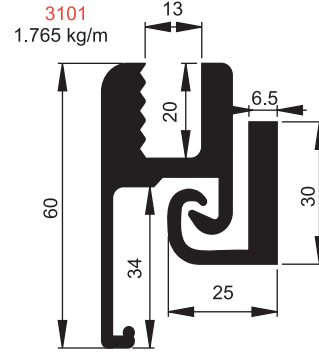

**3101**  
1.765 kg/m

**3102**  
0.820 kg/m  
Pasta Devirme Kanalı

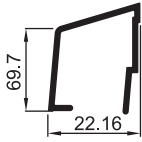

**3106 B**  
0.300 kg/m

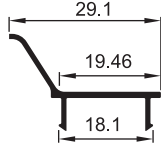

**3106 C**  
0.150 kg/m

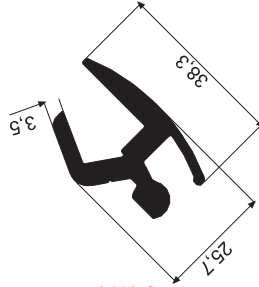

**3116 C**  
0,959 kg/m

**3106**  
1.670 kg/m  
Eski Market Devirme Kanalı

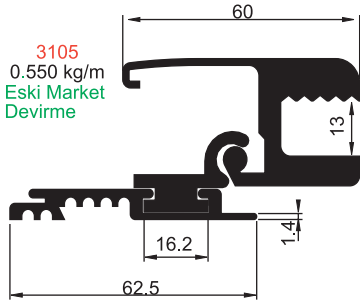

**3105**  
0.550 kg/m  
Eski Market Devirme

**3107**  
0.544 kg/m  
Market Sabitleme Profili

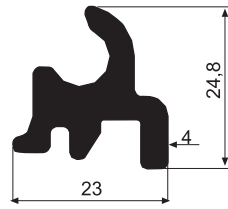

**3117 C**  
0,620 kg/m

**3110 A**  
0.847 kg/m  
Süslü Öne Devirme

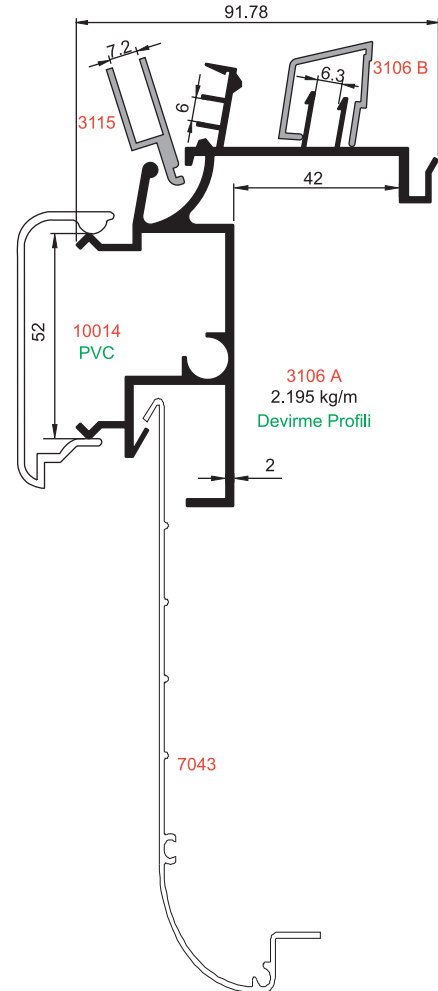

**3106 A**  
2.195 kg/m  
Devirme Profili

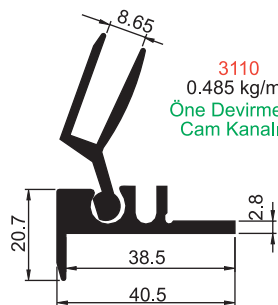

**3110**  
0.485 kg/m  
Öne Devirmeli Cam Kanalı

**3111**  
0.640 kg/m  
Öne Devirme Alt Kanalı

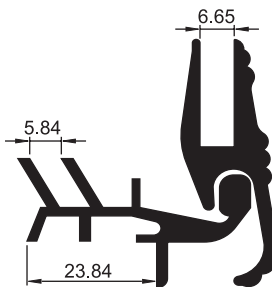

**3111 A**  
0.685 kg/m  
Süslü Devirme Alt

## ALÜMİNYUM / ALUMINUM ÖNE DEVİRME PROFİLLERİ ROLL OVER PROFILES

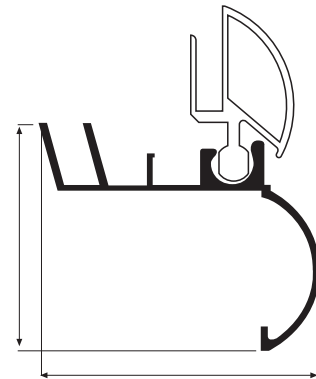
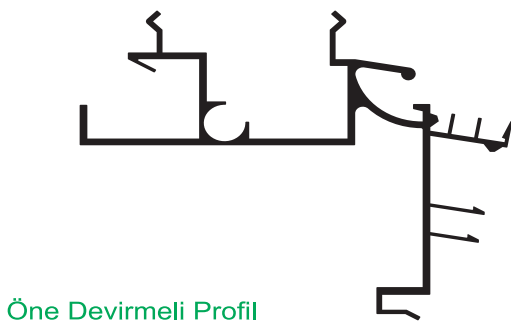
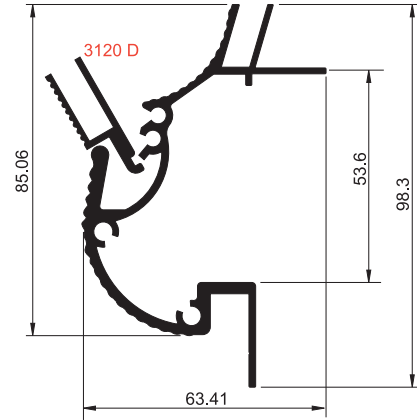
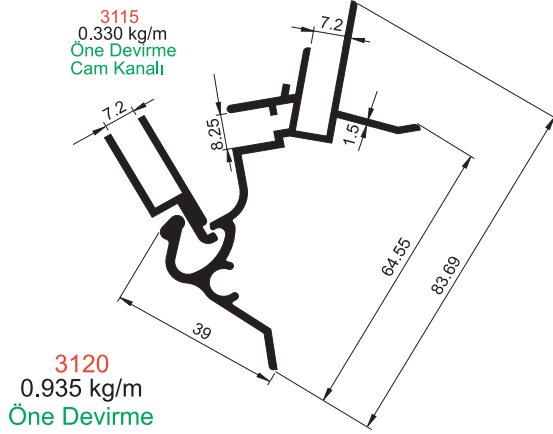
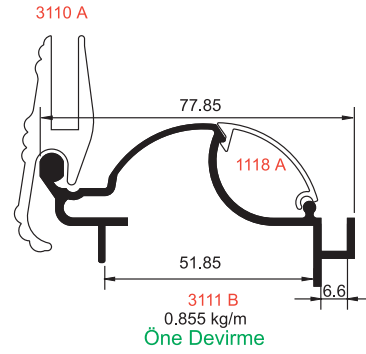
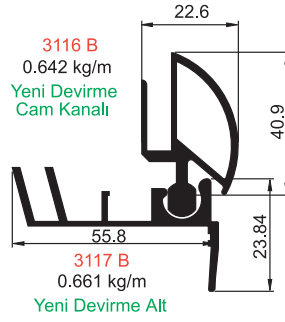
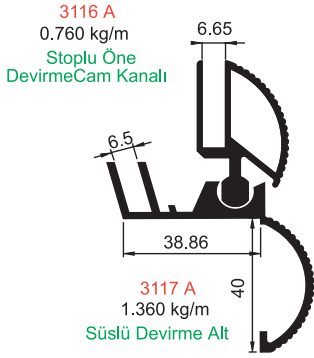
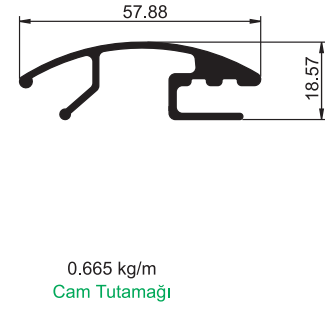
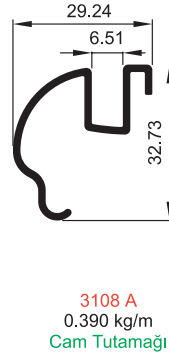
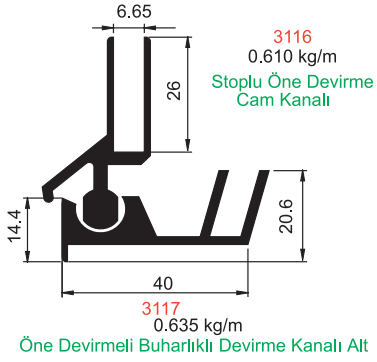

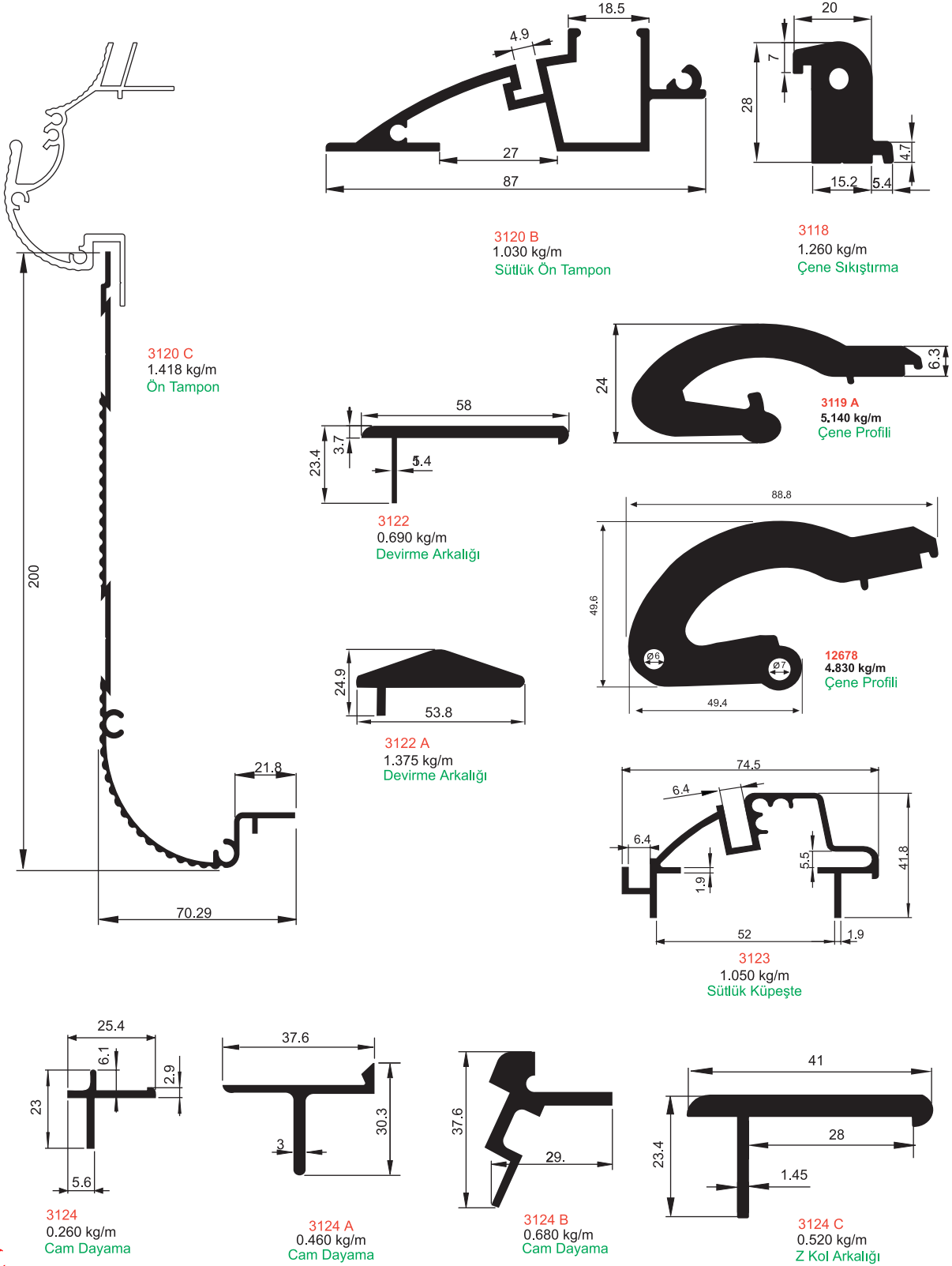

## ALÜMİNYUM / ALUMINUM DONDURMA DOLABI SÜRGÜSÜ SLIDING DOOR PROFILES

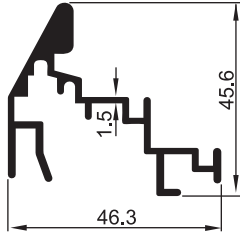

**3125**  
0.885 kg/m  
Dondurma Dolabı Sürgülü  
Cam Kasası

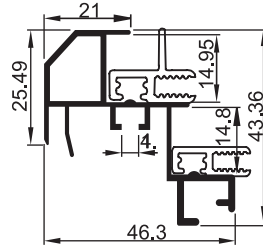

**3125 H**  
0.600 kg/m  
Dondurma Dolabı  
Üst Sürgü Profili

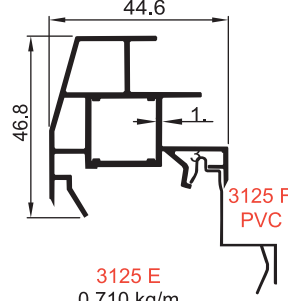

**3125 E**  
0.710 kg/m  
Dondurma Dolabı  
Üst Sürgü Profili

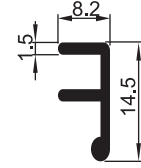

**3125 D**  
0.125 kg/m  
Dondurma Dolabı Profili



**3125 C**  
0.200 kg/m  
Dondurma Dolabı Profili

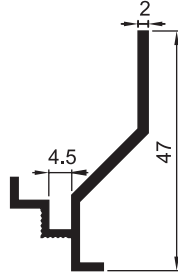

**3125 A**  
0.390 kg/m  
Dondurma Dolabı Profili

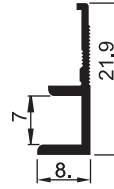

**3125 B**  
0.142 kg/m  
Dondurma Dolabı Profili

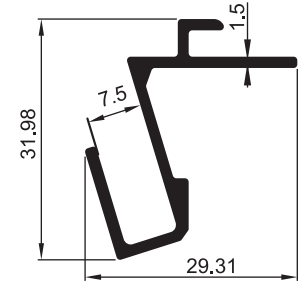

**3128**  
0.370 kg/m  
Dondurma Dolabı Cam Profili

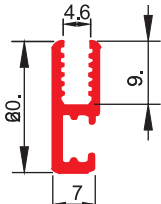

**3125 G**  
PVC  
Dondurma Dolabı  
Cam Çıtası

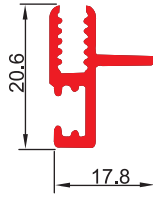

**3125 J**  
PVC  
Dondurma Dolabı  
Cam Çıtası

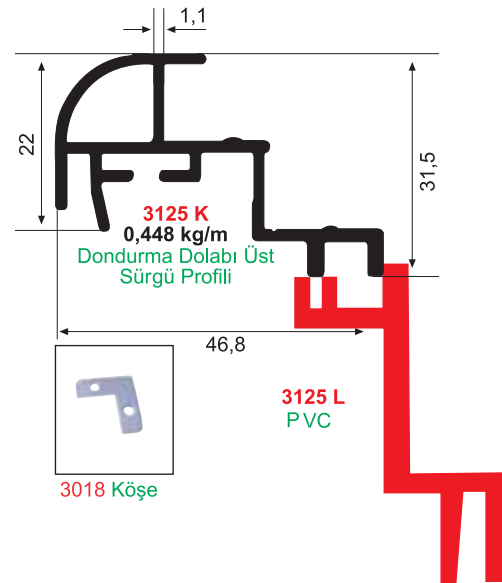

**3125 K**  
0.448 kg/m  
Dondurma Dolabı Üst  
Sürgü Profili

**3125 L**  
PVC

**3018 Köşe**





**ALÜMİNYUM / ALUMINUM**  
**AMORTİSÖRLÜ PROFİLLER**  
**PROFILES WITH DAMPER**

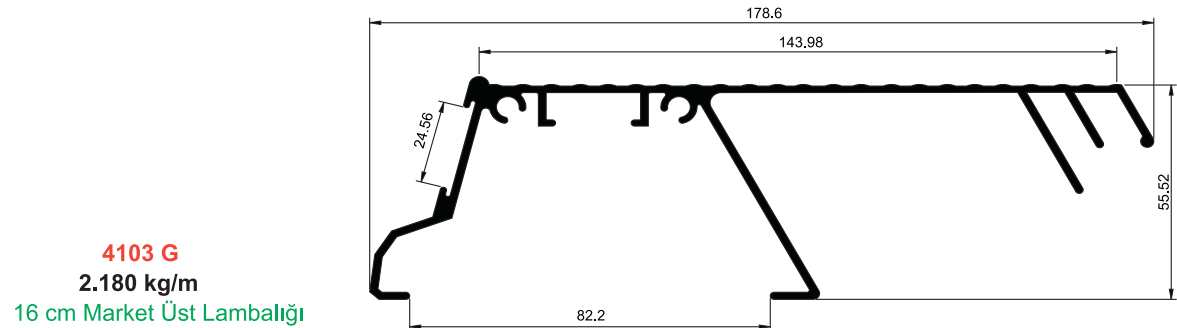
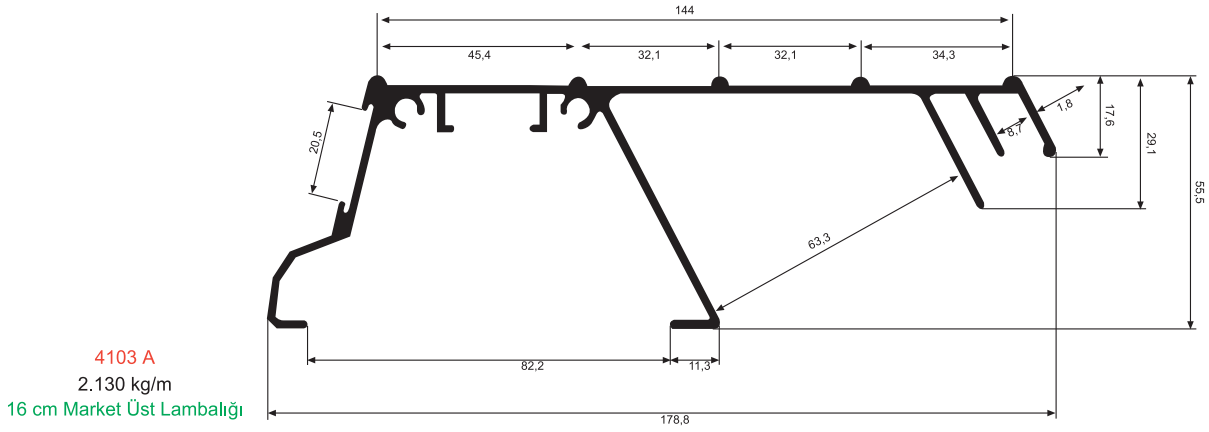
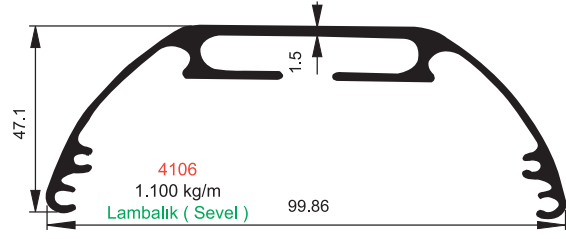
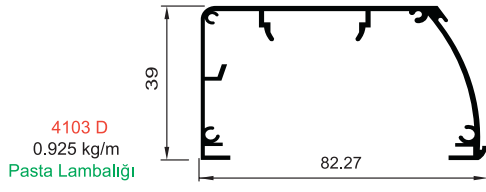
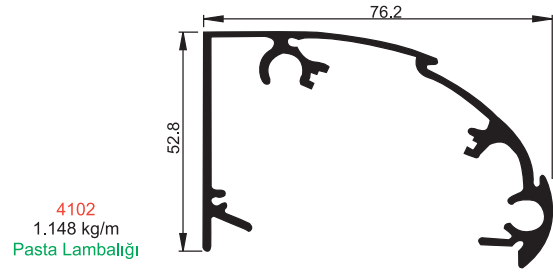
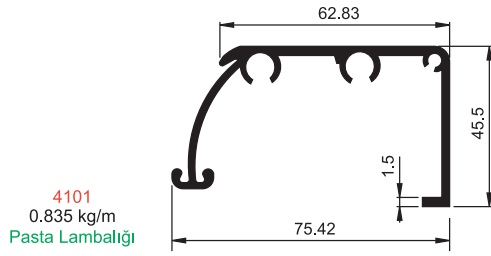



**ALÜMİNYUM / ALUMINUM  
AMORTİSÖRLÜ PROFİLLER  
PROFILES WITH DAMPER**

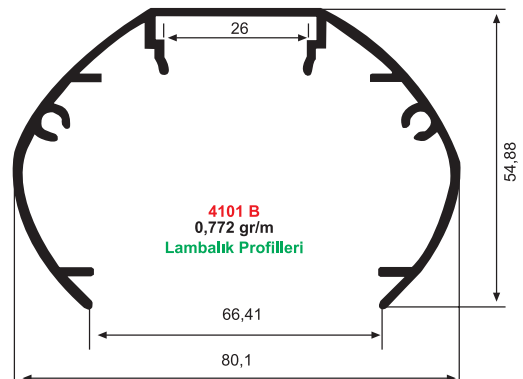
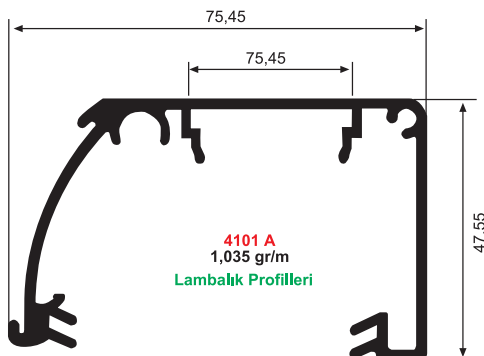
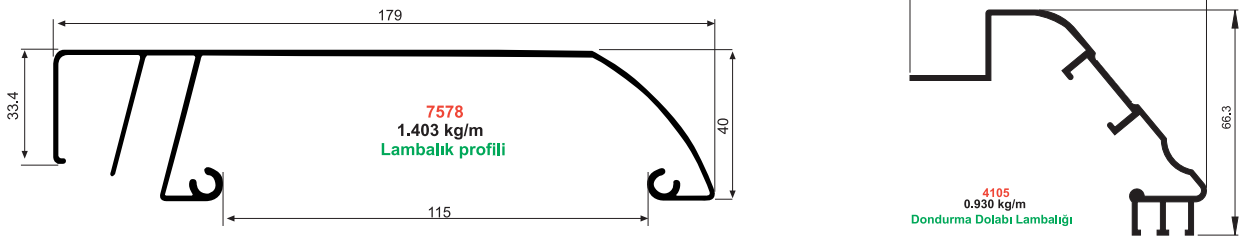
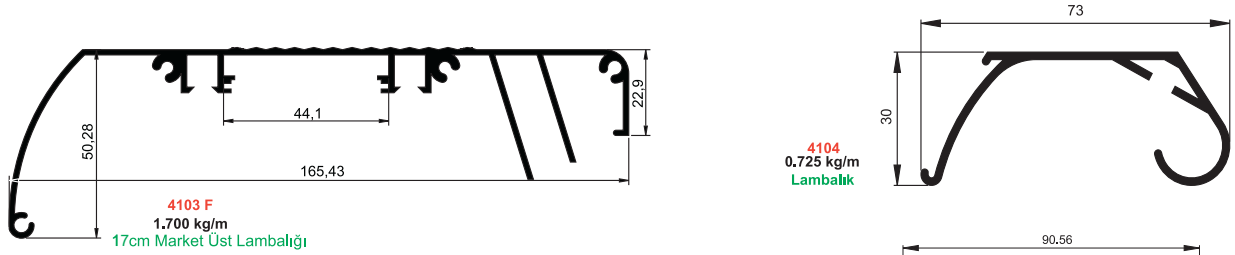
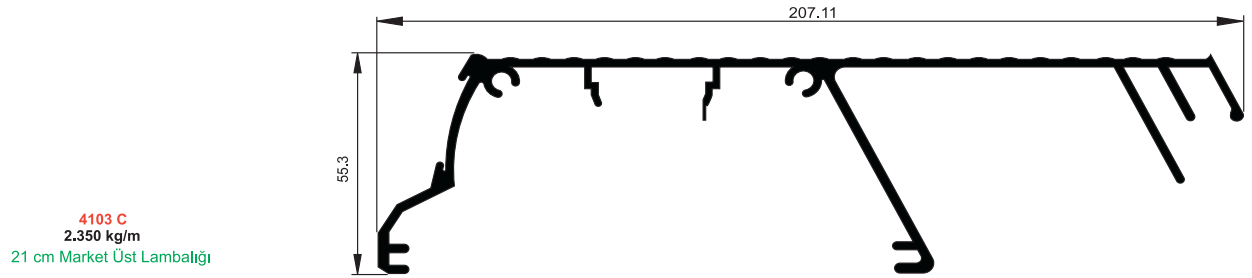
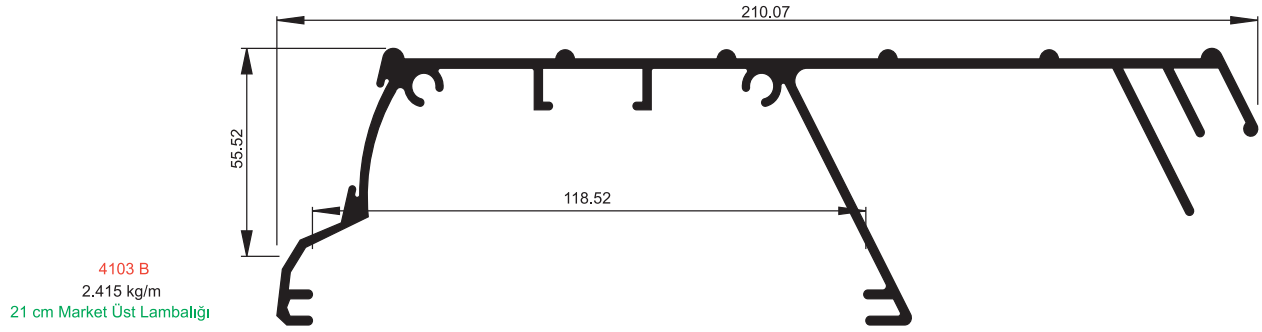





**ALÜMİNYUM / ALUMINUM  
KUYUMCU**

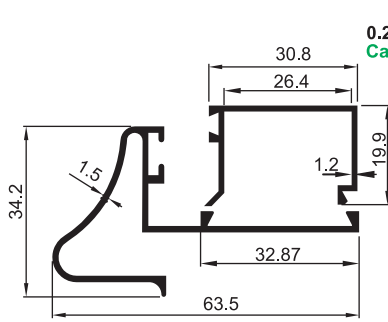
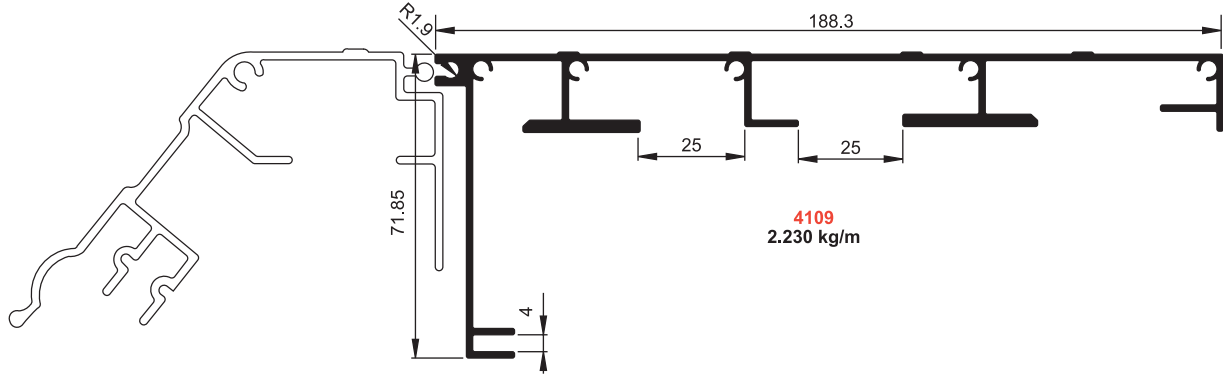
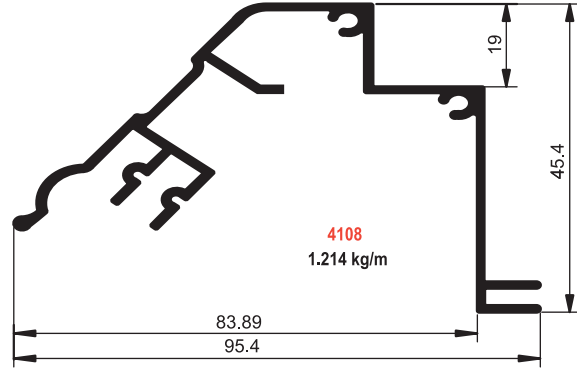
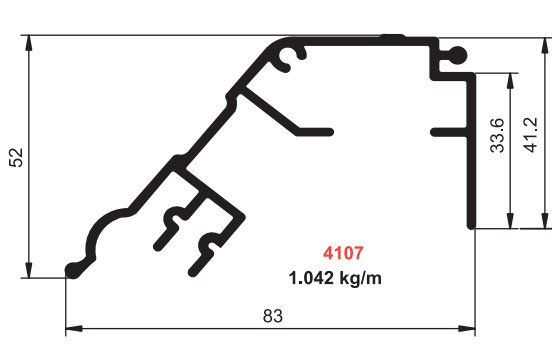

**Aldoks Çıtalı Kuyumcu**

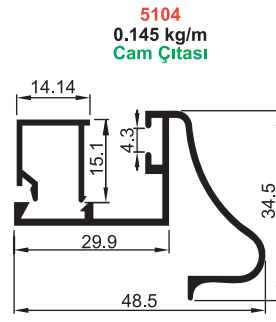

**Küçük Kuyumcu**

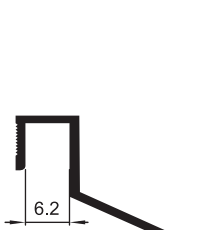
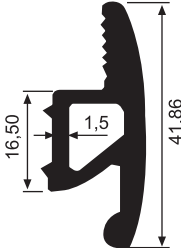
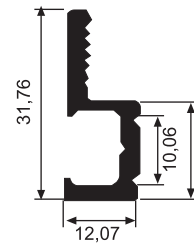

**Menfez Ve Cam Tutacağı**

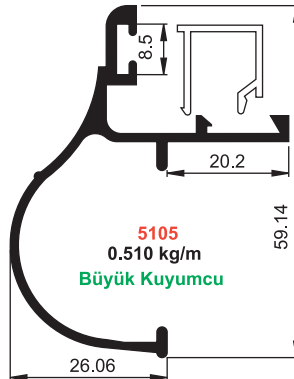

**Büyük Kuyumcu**

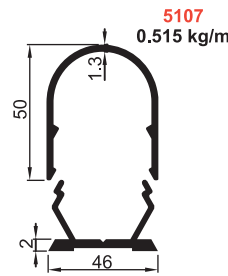

**5108**  
0.370 kg/m  
**50' lik Griyaj**

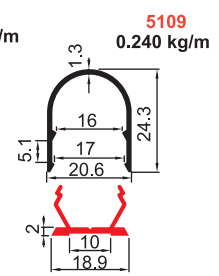

**5110**  
PVC  
**20' lik Griyaj**



**ALÜMİNYUM / ALUMINUM  
ALÜMİNYUM PROFİLLER  
VARIOUS PROFILES**

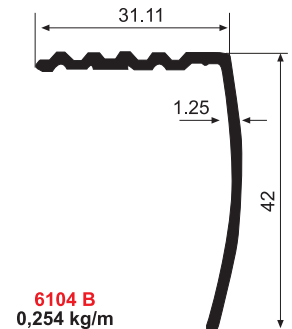
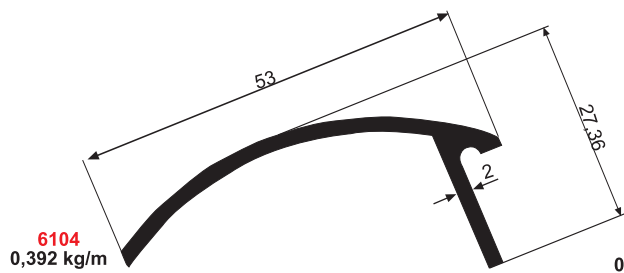
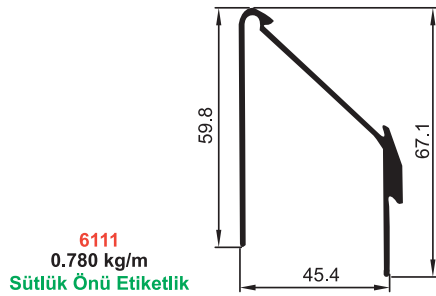
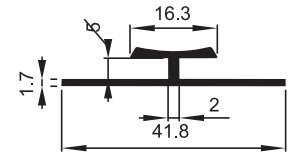
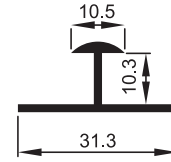
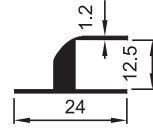
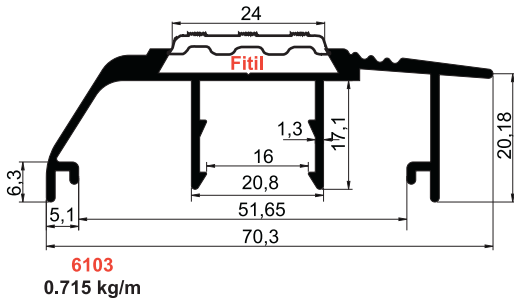
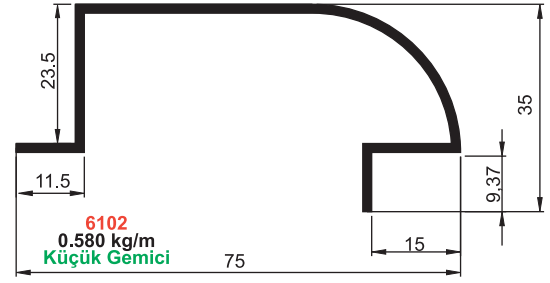
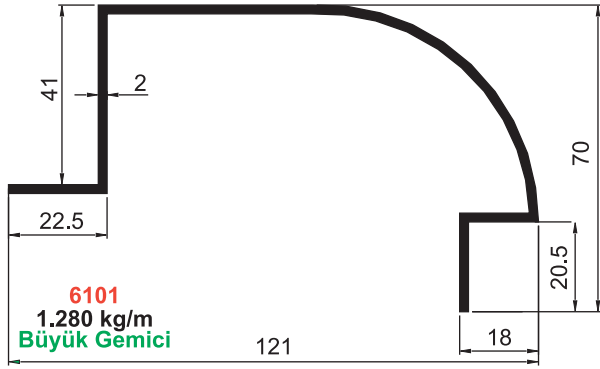



**ALÜMİNYUM / ALUMINUM**  
**ALÜMİNYUM PROFİLLER**  
**VARIOUS PROFILES**

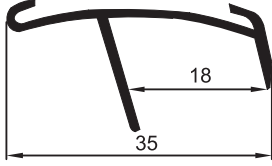

**6113**  
0.370 kg/m  
Etiketlik

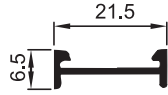

**6114**  
0.100 kg/m  
Sunta Kenarı

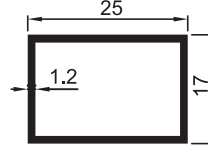

**6118**  
0.270 kg/m  
Kutu Profil

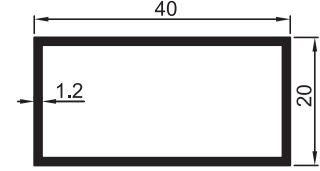

**6118 A**  
0.393 kg/m  
Kutu Profil

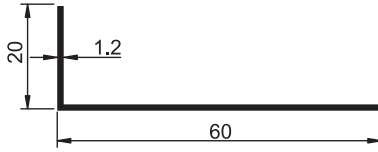

**6119**  
0.270 kg/m  
20x60 Köşebent

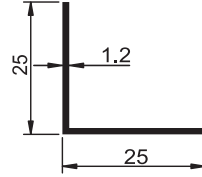

**6119 A**  
0.167 kg/m  
Köşebent

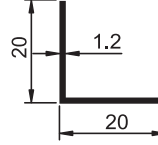

**6119 B**  
0.135 kg/m  
Köşebent

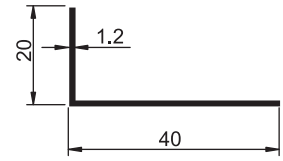

**6119 C**  
0.200 kg/m  
Köşebent

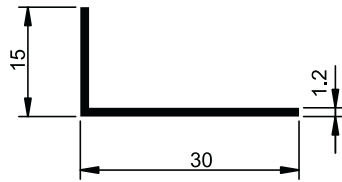

**6119 D**  
0.150 kg/m  
Köşebent



**6119 E**  
0.500 kg/m  
16 ' lık Destek

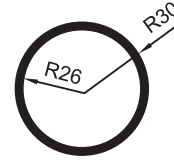

**6119 F**  
0.700 kg/m  
30' luk  
Dikme Borusu

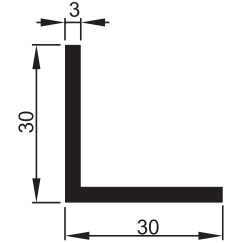

**6119 G**  
0.485 kg/m  
30x30X3mm.  
Köşebent

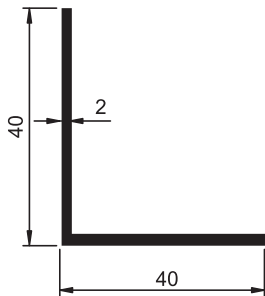

**6119 H**  
0.443 kg/m  
Köşebent

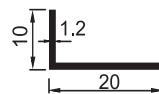

**6119 K**  
0.098 kg/m  
Köşebent

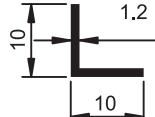

**6119 L**  
0.064 kg/m  
Köşebent

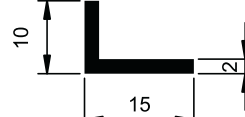

**6119 N**  
0.130 kg/m  
Köşebent

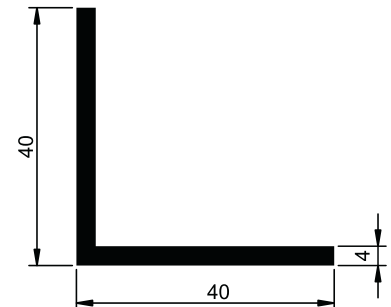

**6119 M**  
0.655 kg/m  
Köşebent



## ALÜMİNYUM / ALUMINUM ALÜMİNYUM PROFİLLER VARIOUS PROFILES

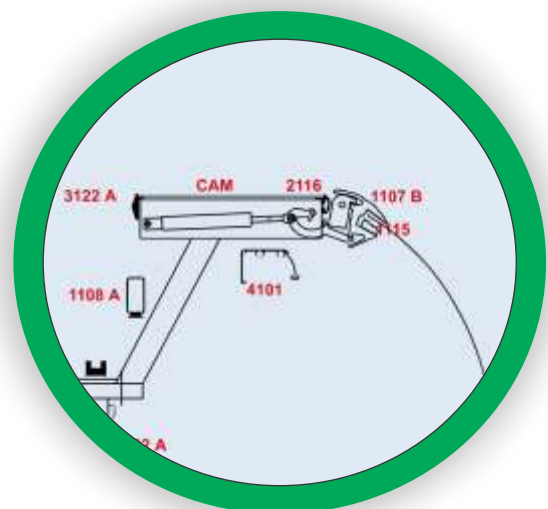
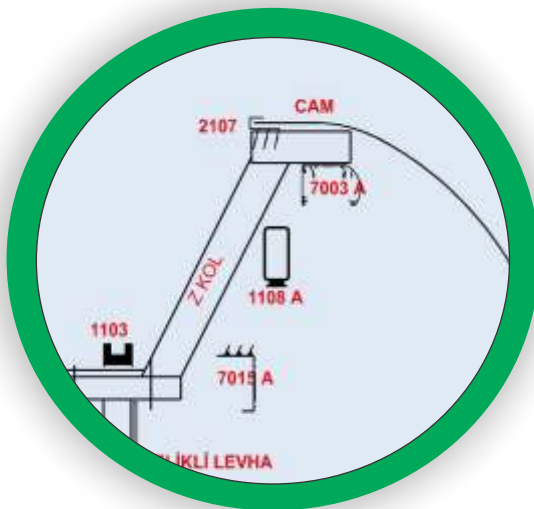
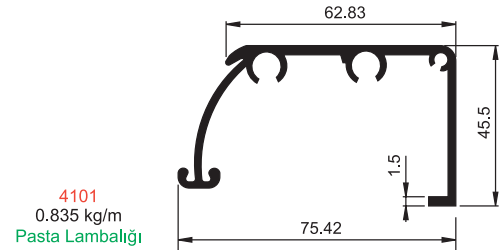
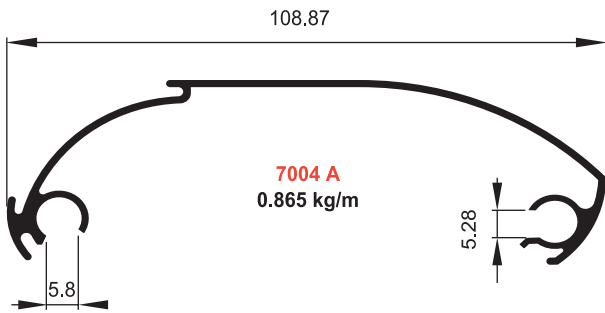
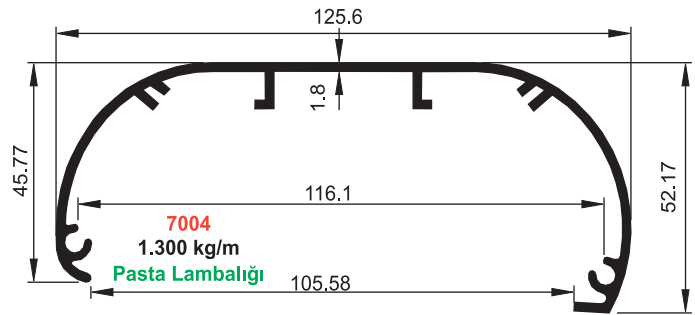
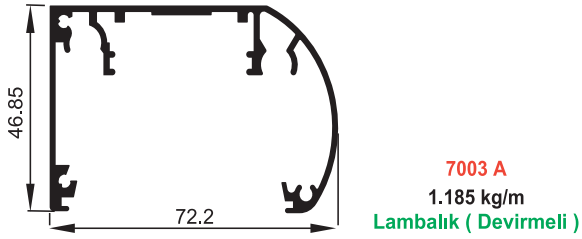
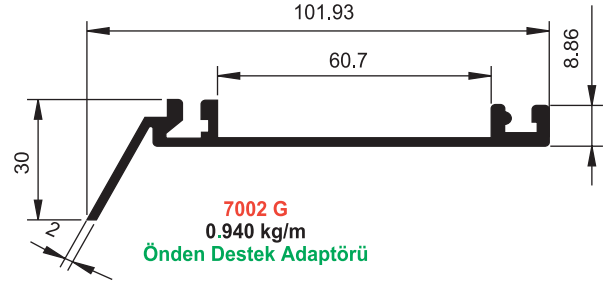
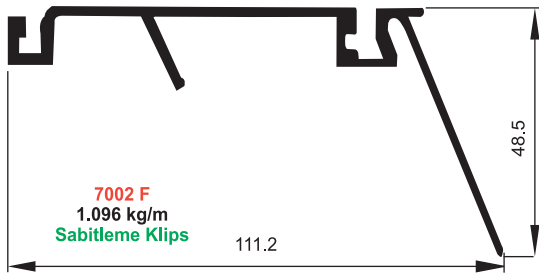



## ALÜMİNYUM / ALUMINUM

Amortisörlü Market Üst Devirme Profili

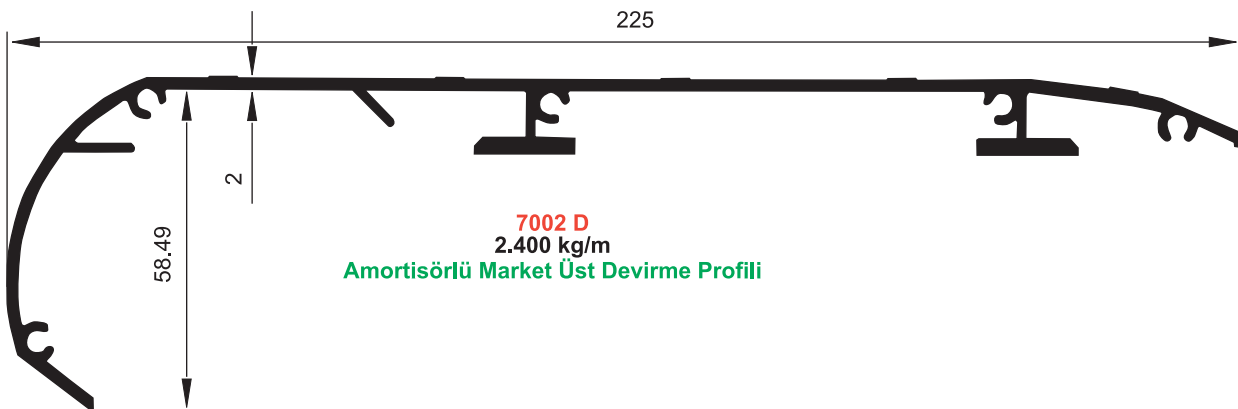
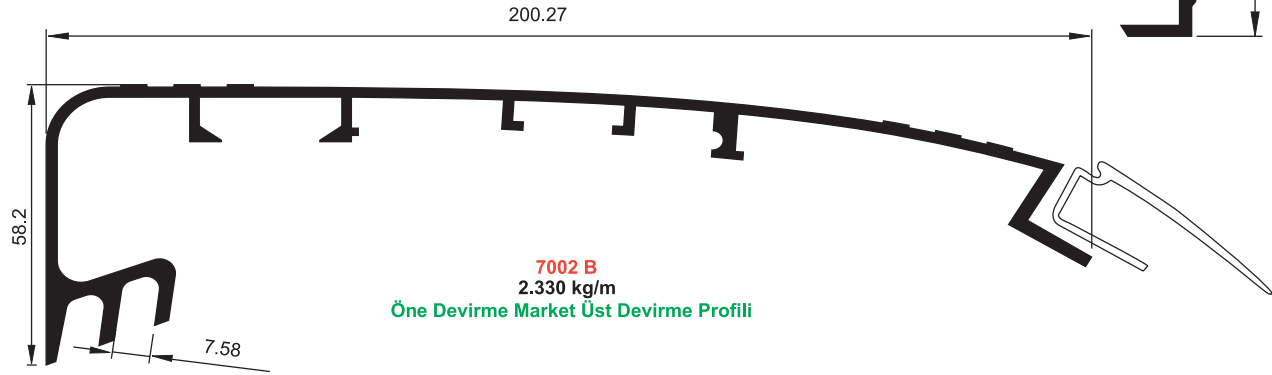
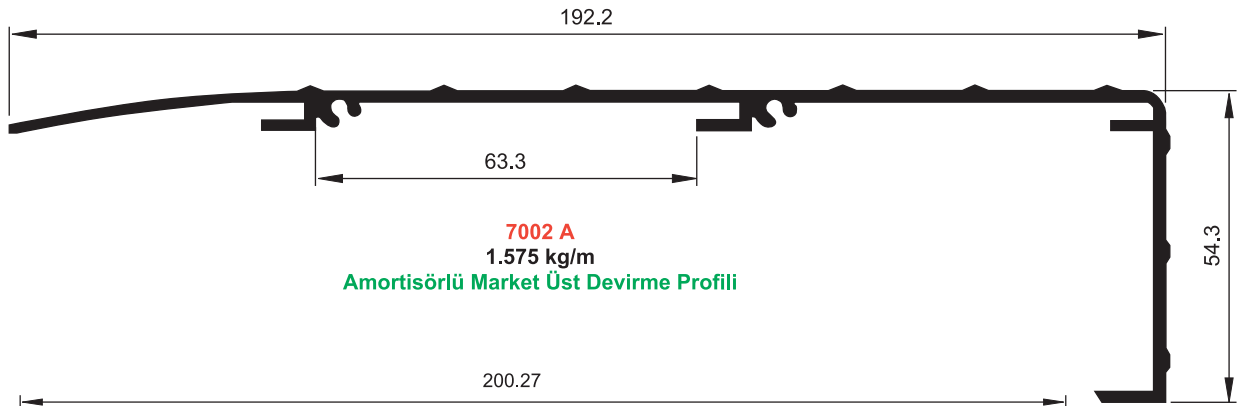
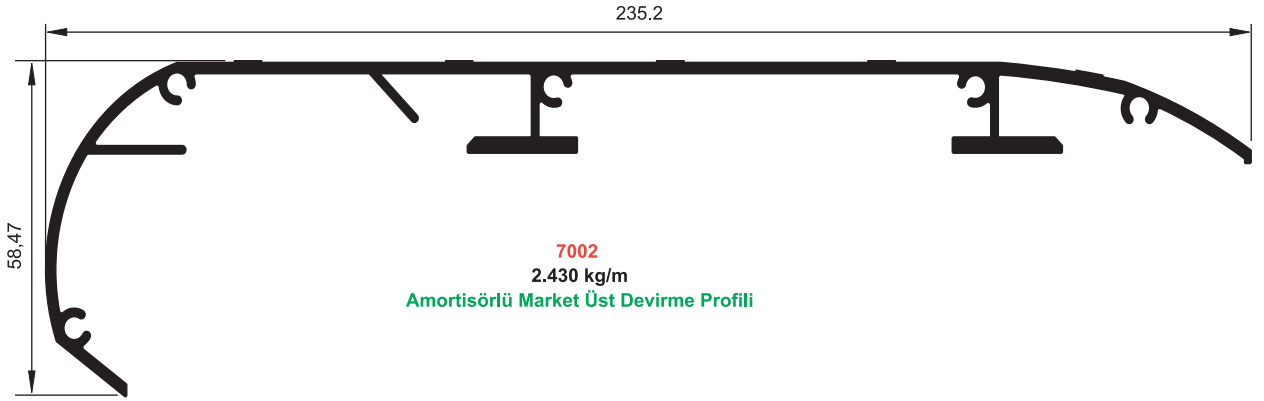



## ALÜMİNYUM / ALUMINUM

Amortisörlü Market Üst Devirme Profili

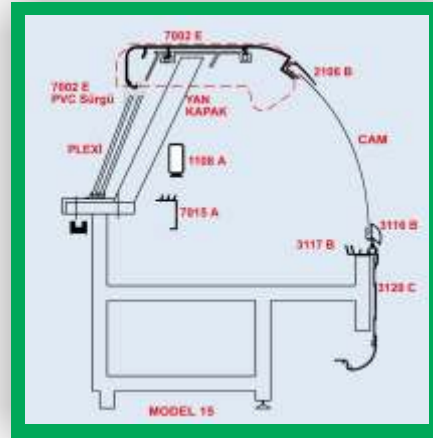
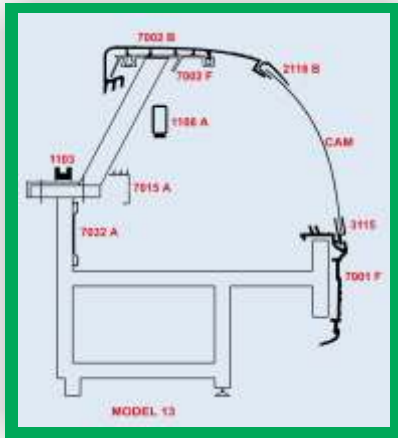
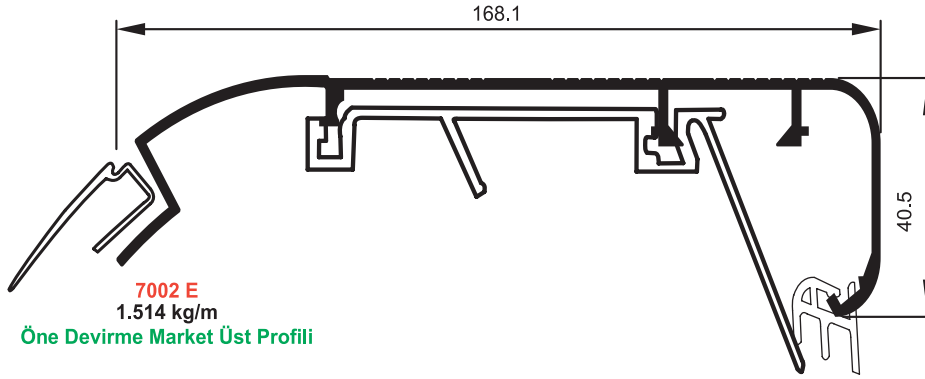
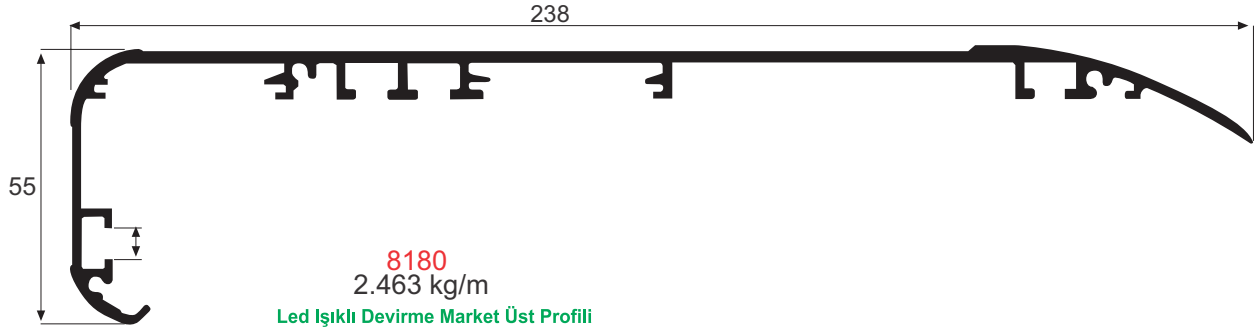
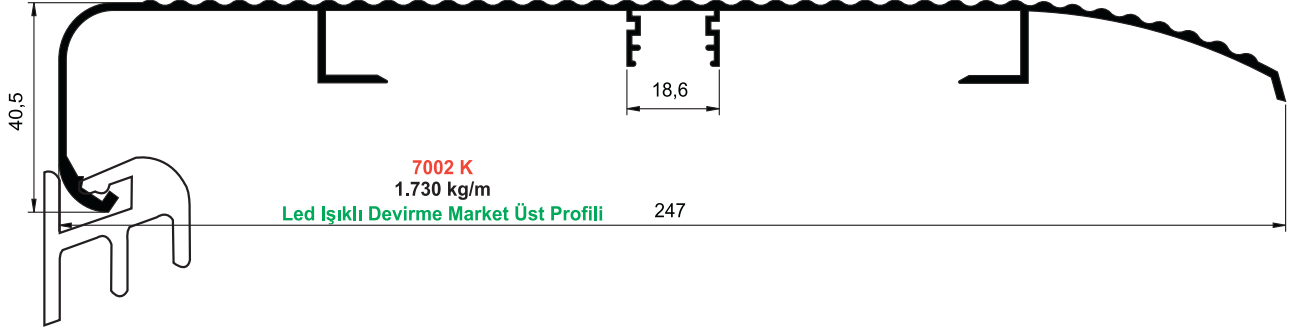



## ALÜMİNYUM / ALUMINUM

### TAMPON PROFİLLERİ BUFFER PROFILES

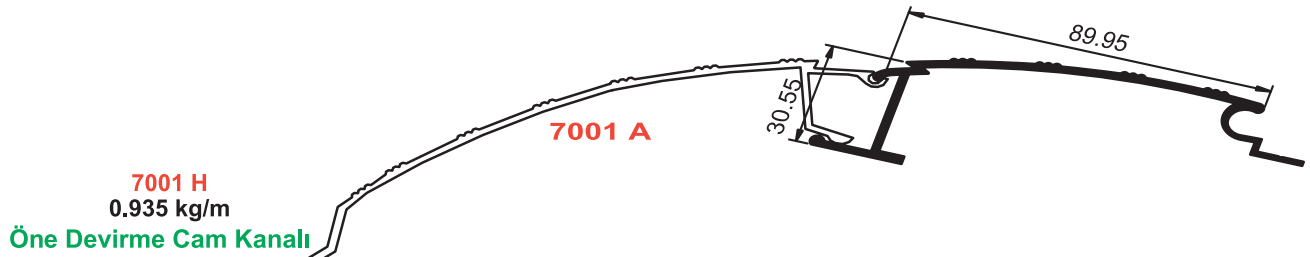
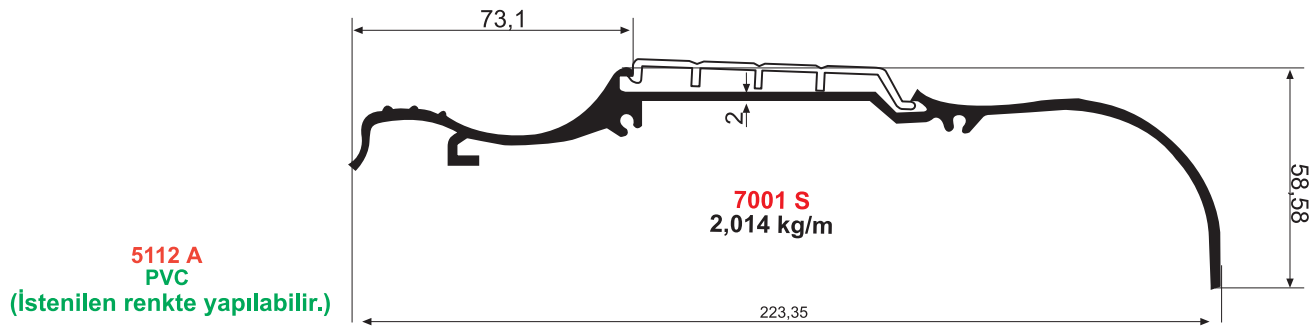
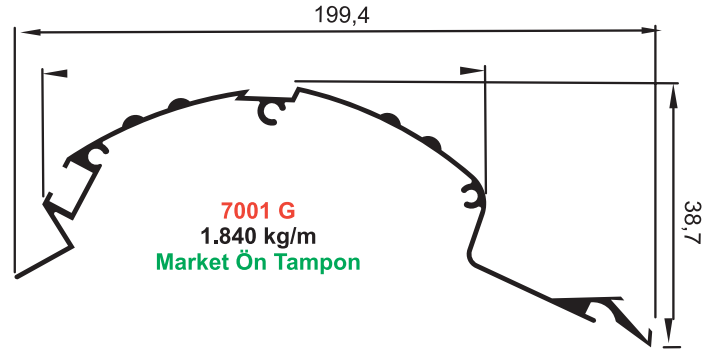
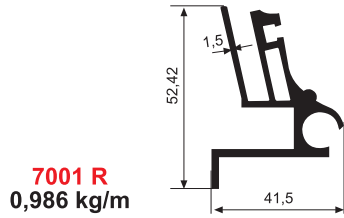
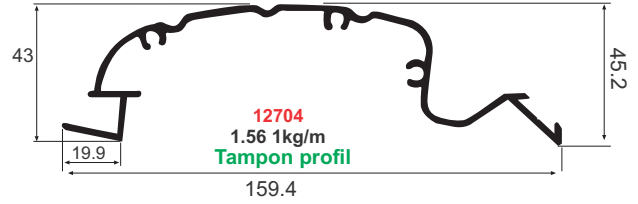
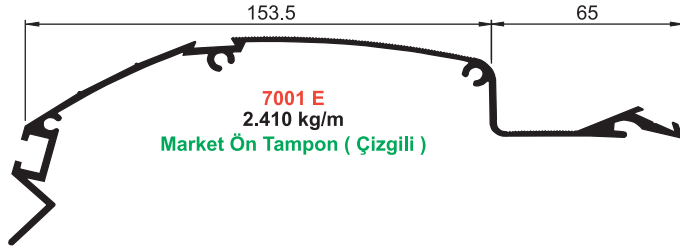
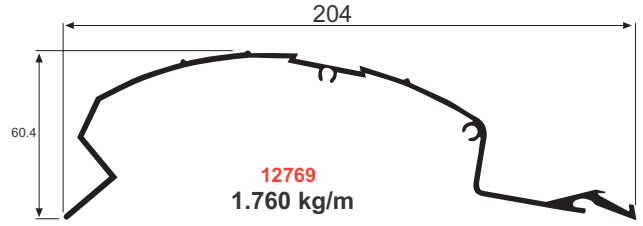
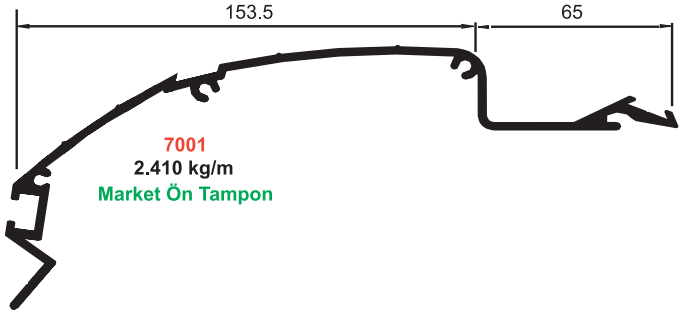

**7001 H**  
0.935 kg/m  
Öne Devirme Cam Kanalı



## ALÜMİNYUM / ALUMINUM TAMPON PROFİLLERİ BUFFER PROFILES

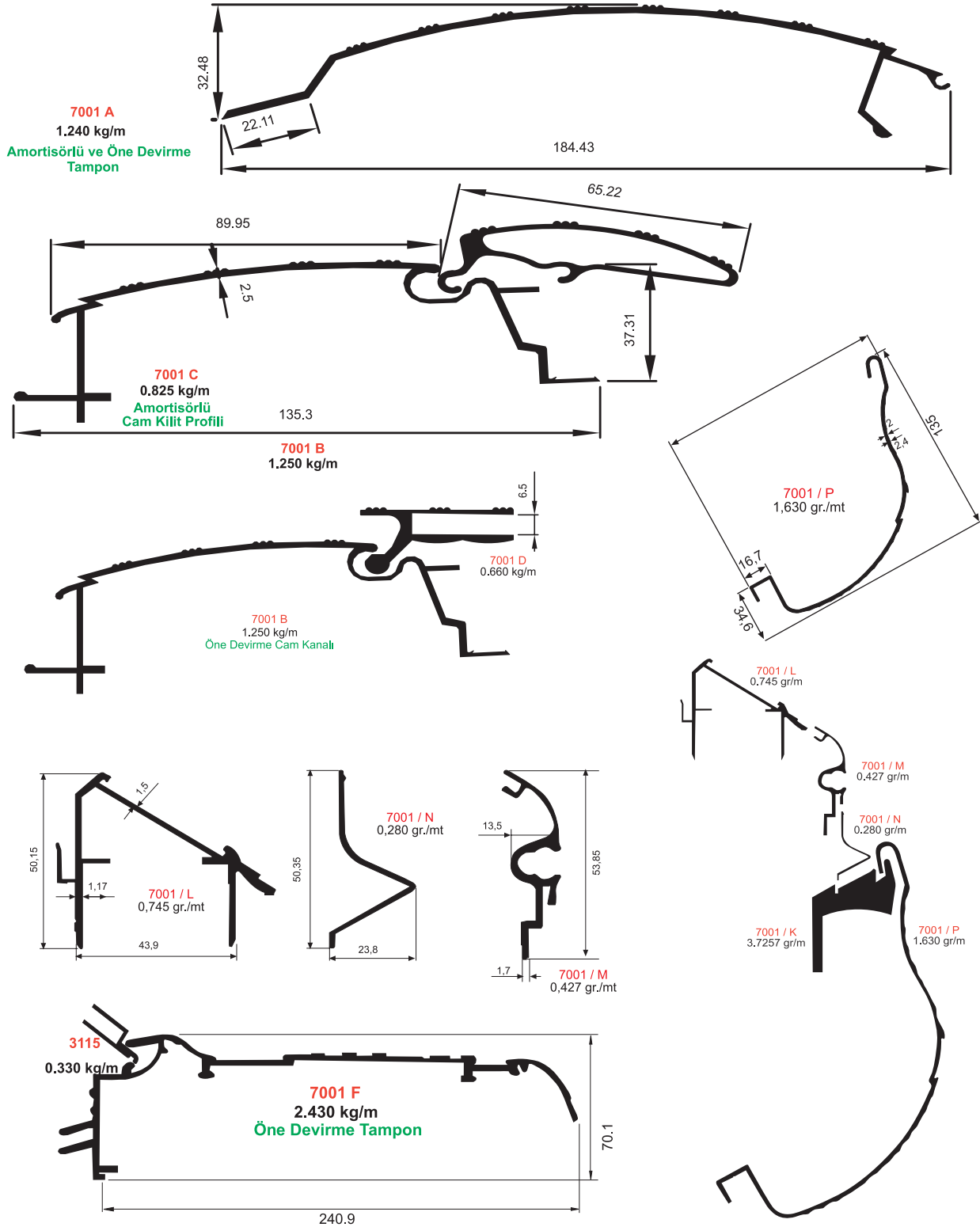





**ALÜMİNYUM / ALUMINUM**  
**SÜTLÜK ALIN PROFİLLERİ**  
**VERTICAL CABINET CORNICE PROFILES**

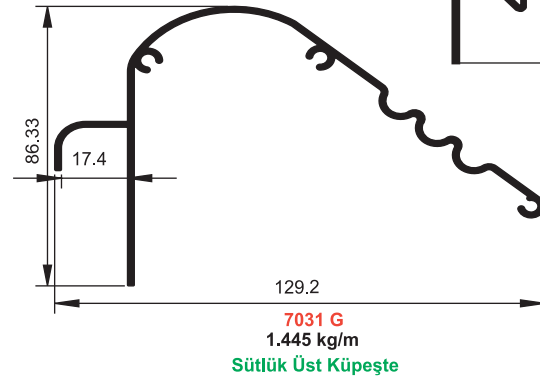
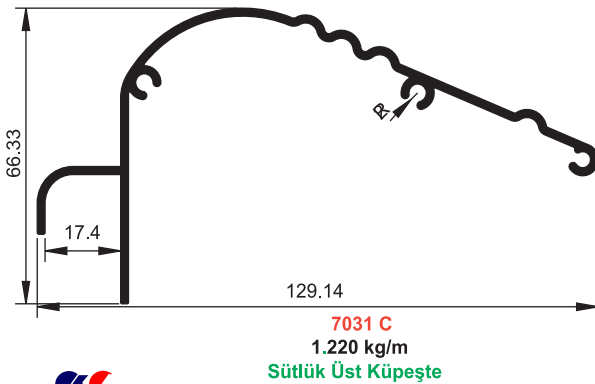
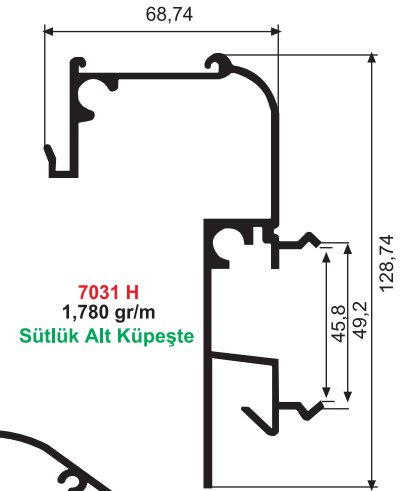
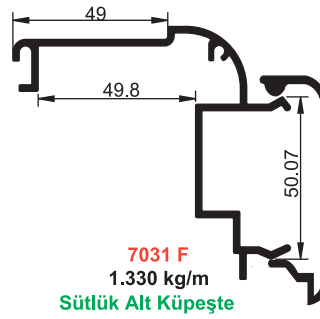
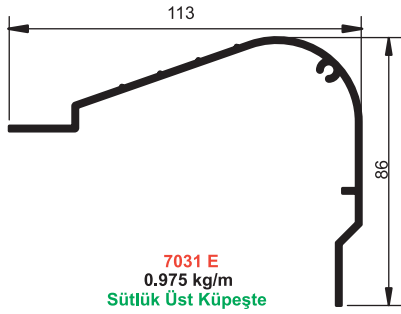
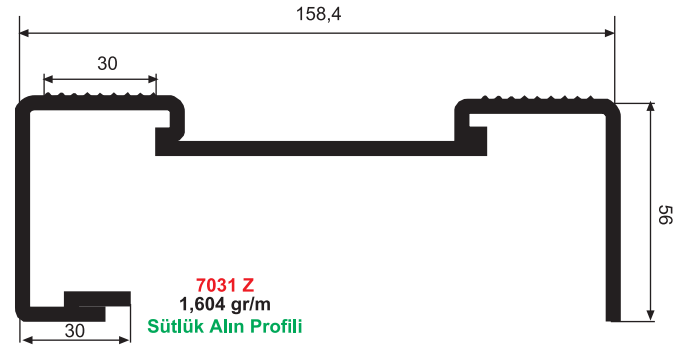
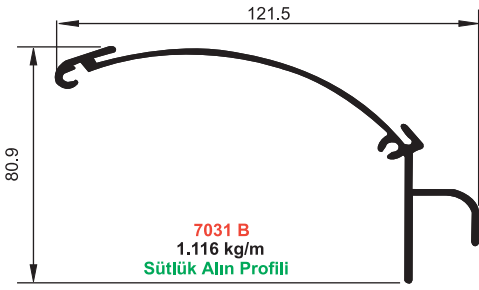
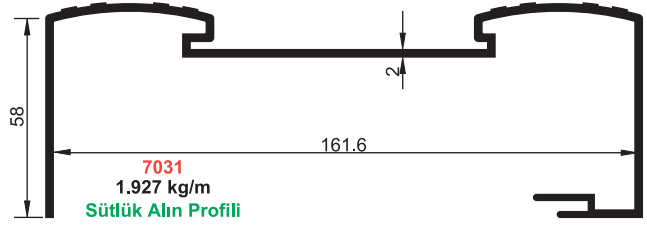
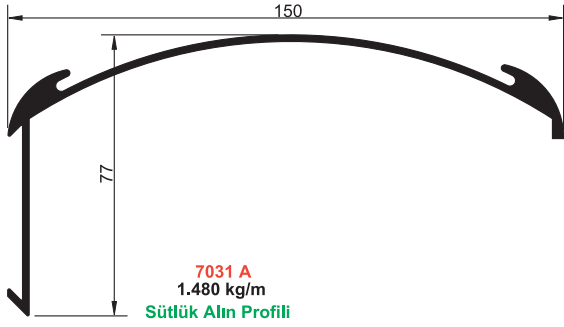



**ALÜMİNYUM / ALUMINUM**  
**SÜTLÜK ALIN PROFİLLERİ**  
**VERTICAL CABINET CORNICE PROFILES**

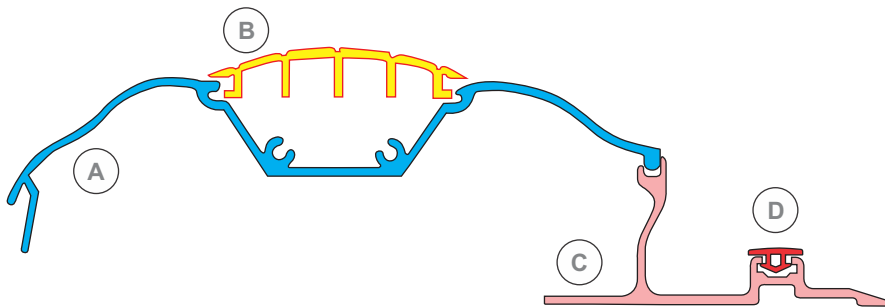
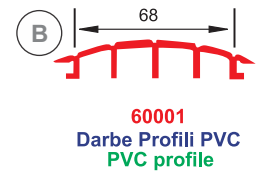
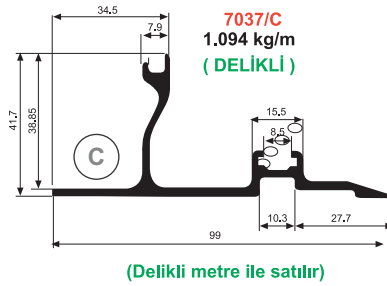
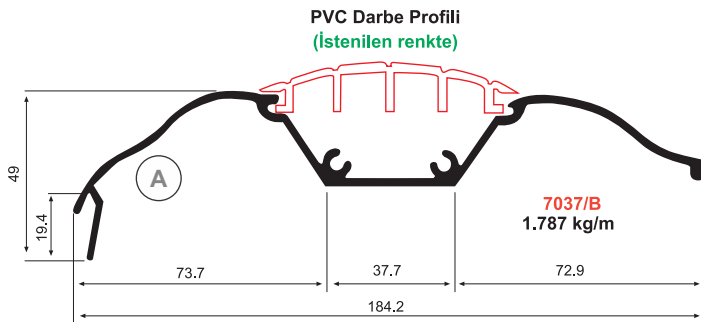
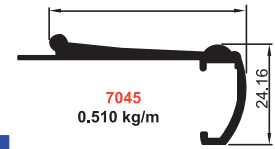
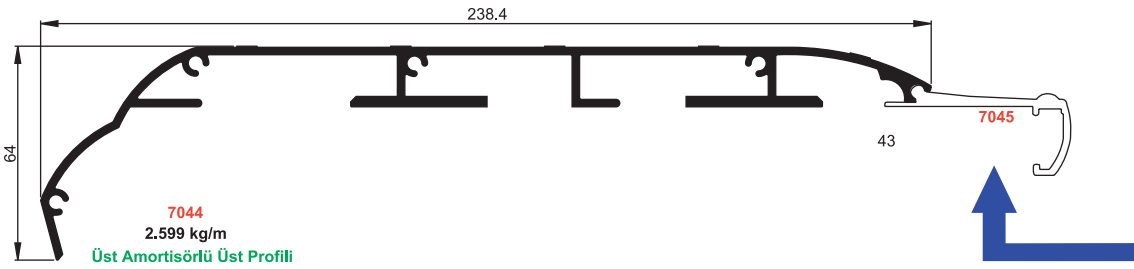
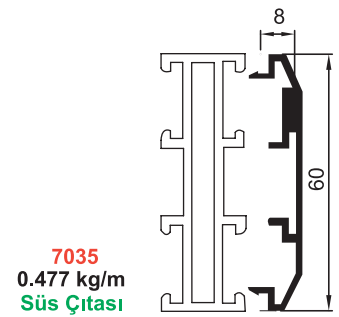
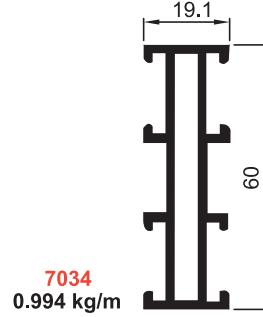
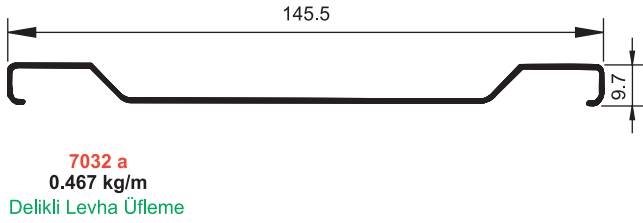
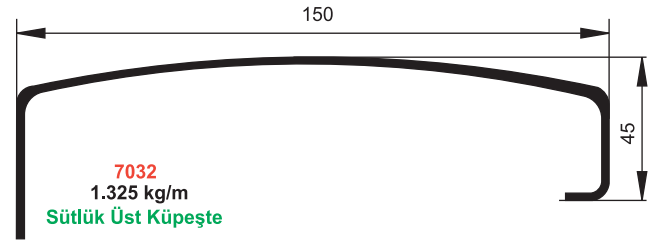
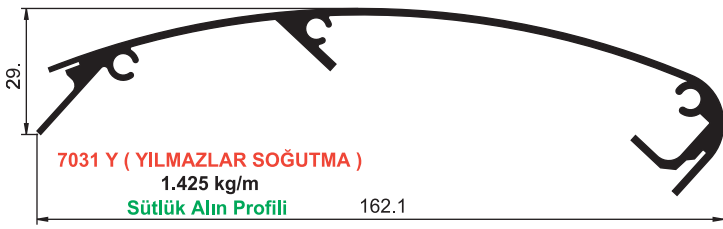



**ALÜMİNYUM / ALUMINUM**  
**SÜTLÜK ALIN PROFİLLERİ**  
**VERTICAL CABINET CORNICE PROFILES**

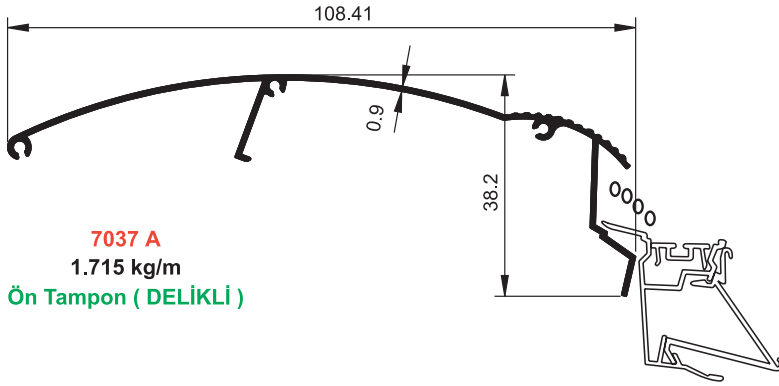

**0.175 kg/m**  
**Rezistans Kapağı**

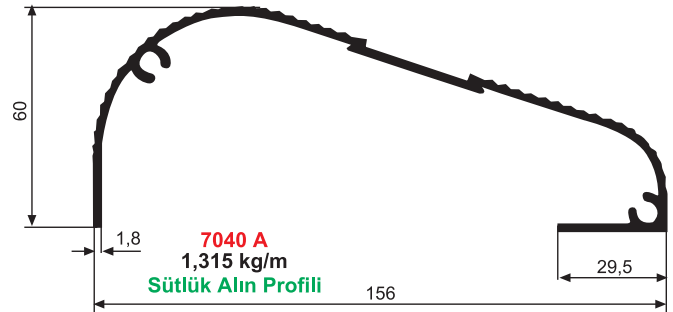
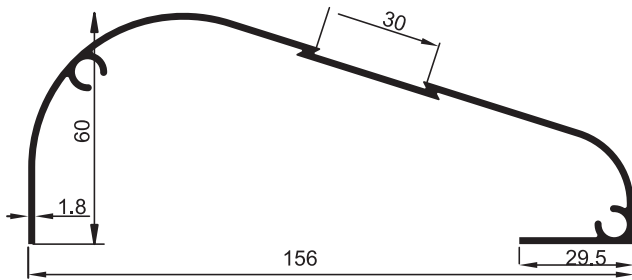
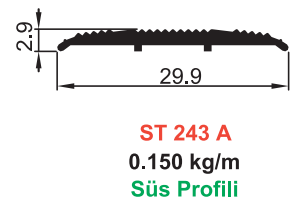
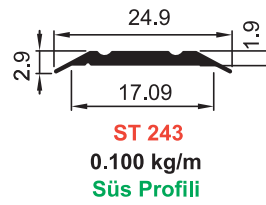
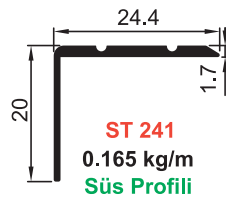
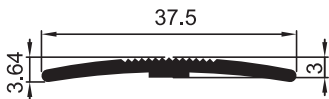
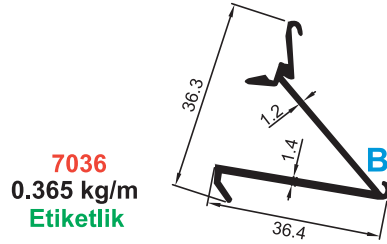
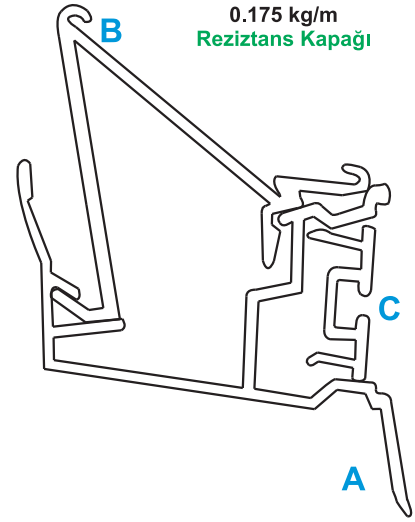



**ALÜMİNYUM / ALUMINUM**  
**SÜTLÜK ALIN PROFİLLERİ**  
**VERTICAL CABINET CORNICE PROFILES**

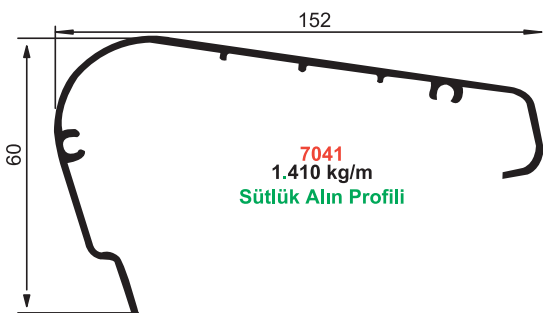
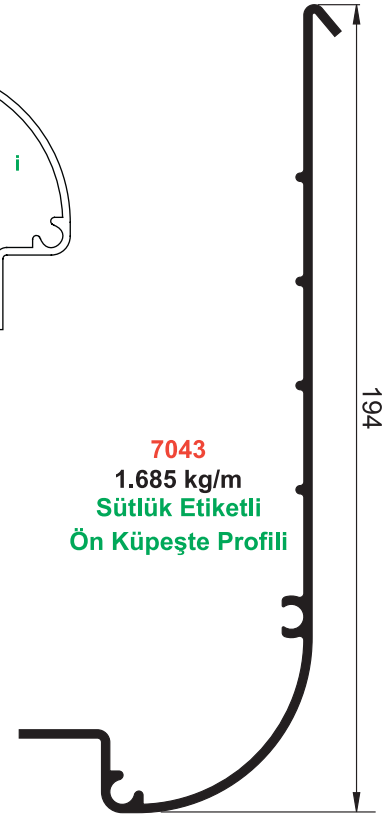
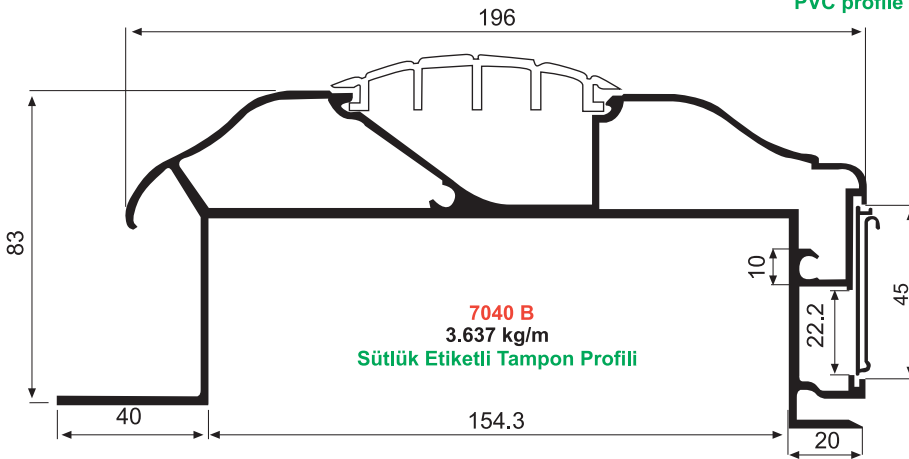
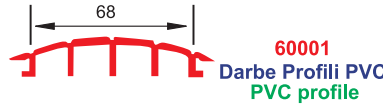
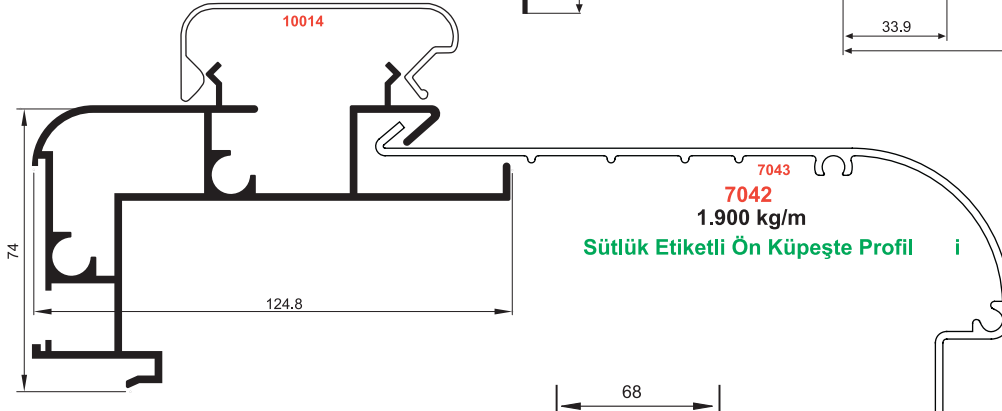
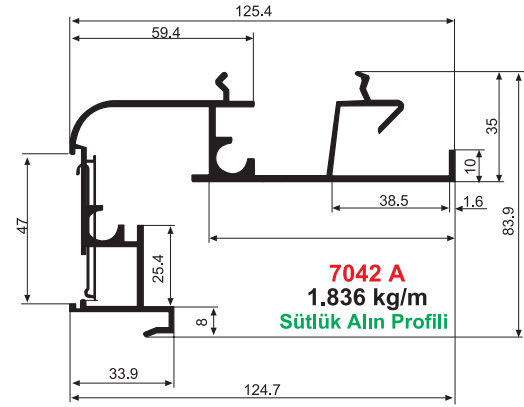
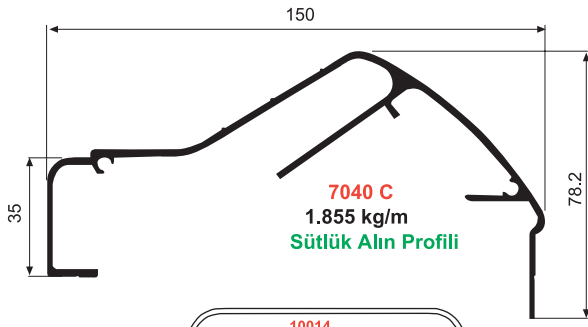



**ALÜMİNYUM / ALUMINUM**  
**ÇERÇEVE PROFİLİ**  
**FRAME PROFILE**

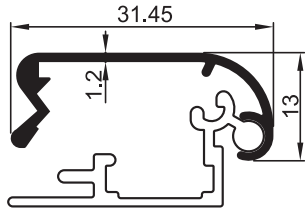

**SM 1067 A**  
**0.323 kg/m**  
**Kapı Çıtası**

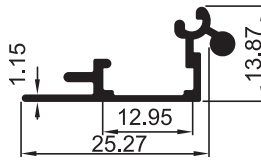

**SM 1067**  
**0.230 kg/m**  
**Görsel Çerçeve Profili**

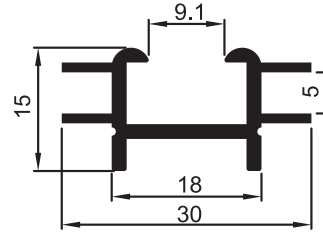

**SM 1068**  
**0.240 kg/m**  
**Aynasız Dikme**

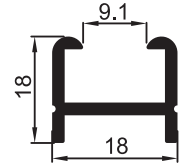

**SM 1068 A**  
**0.240 kg/m**  
**Aynalı Dikme**

**RONDO KÖŞE**





**ALÜMİNYUM / ALUMINUM**  
**KLİMA KASA PROFİLLERİ**  
**AIR CONDITIONER CASE PROFILES**

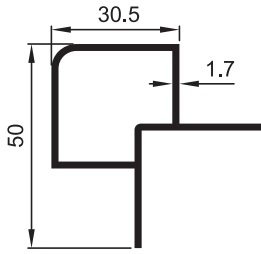

**7010**  
0.735 kg/m  
30'LUK 30 mm

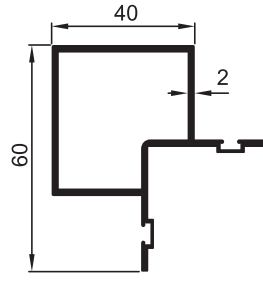

**7009**  
1.090 kg/m  
40'LİK 40 mm

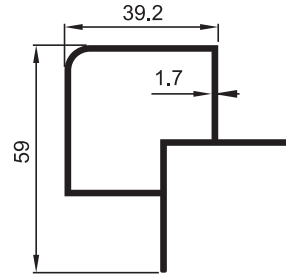

**7007**  
0.900 kg/m  
40'LİK 40 mm

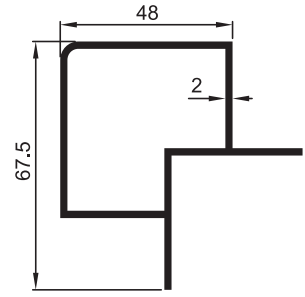

**7008**  
1.255 kg/m  
50'LİK 50 MM

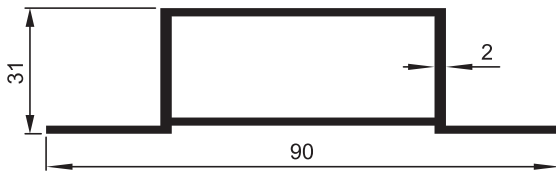

**7011**  
1.100 kg/m  
Orta Kayıt



**Klima Kasa Köşesi**  
30'luk , 40'luk, 50'lik

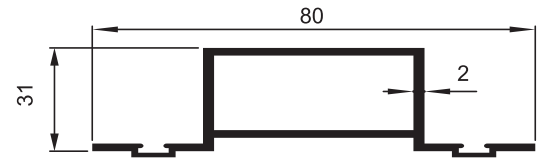

**7012**  
1.000 kg/m  
Fitilli Orta Kayıt

